

reyes ordoñez[®]

Complementos

Butacas

Sillones
Relax

Sofás
Camas

Sofás mecanismo
Motorizado

Sofás mecanismo
Deslizante

Sofás sin
Mecanismo

Sofás sin mecanismo

NEW



Koala
Pág. 10-13

NEW



Line
Pág. 14-17

NEW



Baobab
Pág. 18-21



Zendo
Pág. 22-25



Krema
Pág. 26-29



Tribu
Pág. 30-33



Mirko
Pág. 34-37



Origen
Pág. 38-39

Sofás mecanismo deslizante

NEW



Flamingo
Pág. 40-43

NEW



Flow
Pág. 44-47



Snoopy
Pág. 48-51



Goofy
Pág. 52-55



Ilana
Pág. 56-59



Milano
Pág. 60-63



Cosmo
Pág. 64-67

NEW



Lémur
Pág. 68-71



Tucán / Tucán piel
Pág. 72-79



Papúa
Pág. 80-83

NEW



Íbero
Pág. 84-87



Mustang
Pág. 88-91

NEW



Habana
Pág. 92-95

NEW



Galo
Pág. 96-99

NEW



Magú
Pág. 100-103



Nativa
Pág. 104-107



Angie
Pág. 108-111



Diverso
Pág. 112-115

Sofás cama



Stich
Pág. 116-119



Wanda
Pág. 120-123



Botton
Pág. 124-125

NEW



City
Pág. 128-129

NEW



Genial
Pág. 130-131

NEW



Genio
Pág. 132-133



Gravity
Pág. 134-135



Diverso
Pág. 136-137



Básico
Pág. 138-139



Titán
Pág. 140-141



Oliver
Pág. 142-143



Enzo
Pág. 144-145



Benji
Pág. 146-147



Nativa
Pág. 148-149



Turbo
Pág. 150-151



Happy
Pág. 152-153



Dumbo
Pág. 154-155



Twist
Pág. 156-157

NEW



Aire
Pág. 158-159



Menta
Pág. 160-163



Bora
Pág. 164-165



Tempo
Pág. 166-167



Panda
Pág. 168-169

NEW



Line
Pág. 172-173

NEW



Oruga Baja
Pág. 174-175

NEW



Oruga Alta
Pág. 176-177



Jake
Pág. 178-179



Mate
Pág. 180-181



Moli Lisa
Pág. 182-183



Moli Desenfundable
Pág. 184-185



Moli Capitoné
Pág. 186-187



Mona
Pág. 188-189



Gemma Madera
Pág. 190-191



Gemma Metal
Pág. 192-193



Bimba
Pág. 194-195



Malik / Malik capitoné
Pág. 196-197



Norik / Norik Balancín
Pág. 198-199



Nemo
Pág. 200-201



Moli Lisa Kids
Pág. 202



Moli Desenfundable Kids
Pág. 202



Mona Kids
Pág. 203



Malik Capitoné Kids
Pág. 203



Norik Balancín Kids
Pág. 203

Complementos

Pufs

NEW



Puf pata alta
Pág. 206-207

NEW



Puf arcón pata alta
Pág. 206-207



Puf Capitoné
Pág. 206-207



Puf Liso
Pág. 206-207

Colección Pompa

Mesitas



Espejos / Pomos / Lámparas
Pág. 208



Coffee
Pág. 209



Cruceta
Pág. 209



Pompa
Pág. 209



Zendo
Pág. 209

Cojines

Mascotas



Cojines
Pág. 210-211

NEW



Cuore
Pág. 212

NEW



Mia
Pág. 212



Sofás

Koala

Sofá fijo



Sofá Koala de 226 cm. (2 asientos de 95). Tela Eric 17.



Sofá Koala de 226 cm. (2 asientos de 95). Tela Eric 17.

Respaldo ajustable en dos posiciones.
 Adjustable backrest in two positions.
 Dossier réglable en deux positions.



Estructura de madera de pino y tablero.
Suspensión de muelles zig zag.
Asiento de goma de 35 Kg./m³ + 5 cm. de viscolástica de 50 Kg./m³.
Respaldos de fibra hueca siliconada reciclada.
Almohadas desenfundables.
Pata metálica negra decorativa de 12 cm.
Permite limpieza con robot aspirador.
Se sirve siempre con un brazo desmontado para facilitar el transporte y montaje.

Solid pine wood and fiber board structure.
 Zig zag metallic springs suspension seats.
 Seats with 35 Kg./m³ foam + 5 cm. memory foam of 50 Kg./m³.
 Backrests with recycled silicone hollow fiber.
 Loose covers.
 Hidden union between modules.
 12 cm. decorative black metal leg.
 Allows cleaning with a robot vacuum cleaner.
 It is always served with a disassembled arm to facilitate transport and assembly.

Structure et plateau en bois de pin.
 Suspension à ressort en zigzag.
 Siège en caoutchouc de 35 Kg./m³ + 5 cm. de viscoélastique de 50 Kg.
 Supports en fibres creuses de silicone recyclées.
 Oreillers amovibles.
 Pied décoratif en métal noir de 12 cm.
 Permet le nettoyage avec un robot aspirateur.
 Il est toujours servi avec un bras démonté pour faciliter le transport et le montage.

Koala

Sofá fijo

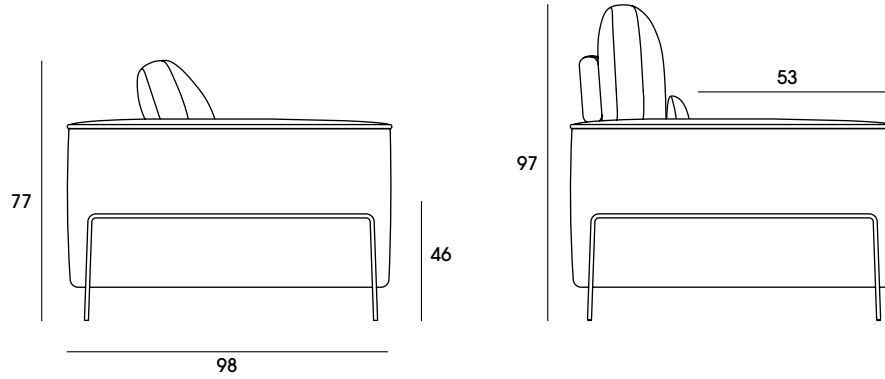

Medidas	Descripción	zero	SA	SB	SC	SD	TC				
	Koala sillón de 131 (1 asiento de 95)	545	586	611	635	660	500	7,3	0,98	42	1
	Koala sillón de 121 (1 asiento de 85)	535	574	598	622	646	491	7,1	0,91	40	1
	Koala sillón de 111 (1 asiento de 75)	524	562	585	608	631	482	6,8	0,83	38	1
	Koala sofá de 226 (2 asientos de 95)	874	936	973	1010	1047	806	11	1,7	73	1
	Koala sofá de 206 (2 asientos de 85)	854	912	948	983	1019	788	10,5	1,55	67,5	1
	Koala sofá de 186 (2 asientos de 75)	833	889	922	956	990	770	10	1,4	65	1
	Koala módulo de 208 (2 asientos de 95 con 1 brazo)	750	780	799	818	836	715	9,2	1,57	64	1
	Koala módulo de 188 (2 asientos de 85 con 1 brazo)	758	807	836	866	895	704	8,7	1,41	61,5	1
	Koala módulo de 168 (2 asientos de 75 con 1 brazo)	712	758	785	813	841	661	8,2	1,27	59	1
	Koala módulo de 113 (1 asiento de 95 con 1 brazo)	450	481	499	518	536	416	5,5	0,85	44	1
	Koala módulo de 103 (1 asiento de 85 con 1 brazo)	439	469	486	504	522	407	5,3	0,77	40	1
	Koala módulo de 93 (1 asiento de 75 con 1 brazo)	404	432	448	465	482	372	5	0,7	38	1

Altura óptima para robot-aspirador.
Optimal height for robot vacuum cleaner.
Hauteur optimale pour robot aspirateur.

Pata de serie/
Standard

PM017
Metal



PM016
Metal

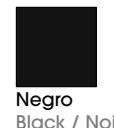
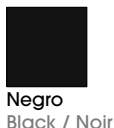
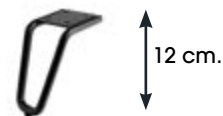

Medidas	Descripción	zero	SA	SB	SC	SD	TC				
	Koala chaise longue de 113 (sentada de 95 con brazo)	599	633	663	696	764	520	7,9	1,45	53	1
	Koala chaise longue de 103 (sentada de 85 con brazo)	574	606	634	666	730	501	7,5	1,32	50,5	1
	Koala chaise longue de 93 (sentada de 75 con brazo)	542	572	599	629	691	471	7,1	1,19	48	1
	Koala rincón 111 x 111	494	524	550	582	644	420	7,5	0,94	38	1
	Koala terminal 135 (sentada de 95)	465	506	531	555	580	420	7,5	1,01	44	1
	Koala terminal 125 (sentada de 85)	455	494	518	542	566	411	7,1	0,94	40	1
	Koala terminal 115 (sentada de 75)	444	482	505	528	551	402	6,8	0,86	38	1
	Koala rincón chaise longue	714	773	807	841	875	655	9	1,71	70	1
	Koala Puf 98 x 98	278	289	298	310	332	242	3,8	0,43	10,5	1
	Koala Puf 95 x 60	265	276	285	295	315	229	3,5	0,25	9,6	1
	Koala Puf 85 x 60	252	261	268	278	297	210	3,4	0,23	8,9	1
	Koala Puf 75 x 60	239	246	251	261	279	191	3,3	0,2	8,4	1

Line

Sofá fijo



Sofá Line de 236 cm. (2 asientos de 108). Tela Lenon 8205.



Sofá Line de 236 cm. (2 asientos de 108). Con brazo siesta desenfundable. Tela Naomi 01.

Estructura de madera de pino y tablero.
Asiento de goma Vefer 32 Kg./m³ S. + 3cm. de viscolástica.
Respaldos de fibra hueca siliconada PLUS efecto plumón.
Almohadas desenfundables.
Unión entre módulos oculta.
Pata metálica negra de 12 cm.
Permite limpieza con robot aspirador.
Brazo recto, de serie (Incluye 1 cojín con relleno efecto plumón por brazo.)
Brazo almohada opcional, con incremento (NO incluye cojín decorativo)

Solid pine wood and fiber board structure.
32Kg./m³ Vefer rubber seat + 3cm. + viscoelastic.
Backrests with PLUS silicone hollow fiber quill effect.
Loose covers.
Hidden union between modules.
12 cm. black metal leg.
Allows cleaning with a robot vacuum cleaner.
Straight arm, as standard. (Includes 1 cushion per arm.)
Optional pillow arm with increase (Does NOT include decorative cushion)

Structure et plateau en bois de pin.
Siège en caoutchouc 33Kg./m³ + viscoélastique.
Dossiers en fibre creuse siliconée PLUS effet duvet.
Oreillers amovibles.
Union cachée entre les modules.
Pied en métal noir de 12 cm.
Permet le nettoyage avec un robot aspirateur.
Accoudoir droit, standard (Comprend 1 coussin avec rembourrage effet duvet PLUS par accoudoir.)
Bras d'oreiller en option avec augmentation (N'inclut PAS le coussin décoratif).



Composición Line de 329 cm. x 200 cm.
(2 asientos de 108 + rincón chaise longue). Tela Lenon 8205.

Pata de serie/
Standard

PM012
Metal

12 cm.

Negro
Black / Noir

Altura óptima para robot-aspirador.
Optimal height for robot vacuum cleaner.
Hauteur optimale pour robot aspirateur.



Sólo el brazo recto incluye cojín de 50x55 cm.
Only the straight arm includes a 50x55 cm. cushion.
Seul le bras droit comprend un coussin de 50x55 cm.



Butaca Line a juego

pag. 172

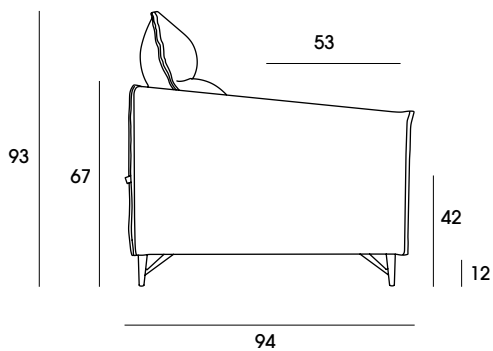

Line

Sofá fijo

Medidas	Descripción	zero	SA	SB	SC	SD	TC				
	Line butaca (1 asiento de 58)	407	432	449	466	483	373	4,8	0,36	42	1
	Line composición chaise longue 334 (2 asientos de 108 + chaise de 98)	1671	1781	1854	1928	2001	1524	19,4	2,12	134	2
	Line composición chaise longue 314 (2 asientos de 98 + chaise de 98)	1631	1739	1810	1882	1954	1488	18,4	2,01	127	2
	Line composición chaise longue 284 (2 asientos de 88 + chaise de 88)	1557	1660	1728	1797	1865	1421	17,4	1,82	115	2
	Line composición chaise longue 264 (2 asientos de 78 + chaise de 88)	1520	1620	1687	1753	1820	1387	16,4	1,72	107	2
	Line sofá 344 (3 asientos de 108)	1529	1627	1692	1757	1822	1399	18,3	1,78	140	2
	Line sofá 314 (3 asientos de 98)	1468	1561	1623	1686	1748	1343	17,2	1,62	129	2
	Line sofá 284 (3 asientos de 88)	1406	1496	1555	1615	1675	1287	16,1	1,47	117	2
	Line sofá 254 (3 asientos de 78)	1348	1434	1491	1548	1605	1234	15	1,31	105	2
	Line sofá 236 (2 asientos de 108)	1068	1137	1183	1229	1275	975	14,7	1,22	97,5	1
	Line sofá 216 (2 asientos de 98)	1028	1095	1139	1183	1228	940	12	1,12	89,8	1
	Line sofá 196 (2 asientos de 88)	989	1053	1095	1138	1180	904	11,3	1,01	81,9	1
	Line sofá 176 (2 asientos de 78)	952	1013	1053	1094	1135	870	10,6	0,91	73,8	1
	Line módulo de 216 (2 asientos de 108 SIN BRAZO)	826	882	920	958	996	750	9,9	1,11	85,9	1
	Line módulo de 196 (2 asientos de 98 SIN BRAZO)	786	840	876	913	949	714	9,1	1,01	78,2	1
	Line módulo de 176 (2 asientos de 88 SIN BRAZO)	747	798	833	867	901	679	3,3	0,91	70,3	1
	Line módulo de 156 (2 asientos de 78 SIN BRAZO)	710	759	791	824	856	645	7,6	0,8	62,2	1

*Las medidas y precios de las composiciones son con el brazo **recto de serie**. Para brazo almohada se calculará el precio sumando los módulos.

Medidas	Descripción	zero	SA	SB	SC	SD	TC				
	Line módulo 108 (SIN BRAZO)	461	490	509	528	547	424	5	0,56	42,9	1
	Line módulo 98 (SIN BRAZO)	440	467	485	503	521	403	4,6	0,5	39,1	1
	Line módulo 88 (SIN BRAZO)	418	443	460	477	495	383	4,3	0,45	35,1	1
	Line módulo 78 (SIN BRAZO)	397	421	437	454	470	364	4	0,4	31,1	1
	Line chaise longue 108 (sentada de 98)	724	771	803	834	866	661	7,5	0,95	43	1
	Line chaise longue 98 (sentada de 88)	689	734	765	795	825	629	7	0,86	39	1
	Line rincón 103 x 103	564	601	625	650	674	515	7,5	0,86	38	1
	Line rincón chaiselongue (incluye 1 cojín decorativo)	883	947	990	1032	1075	798	11	1,66	65	1
42	Line pouf cuadrado 98 x 98	230	244	253	263	272	211	2,5	0,29	15	1
42	Line pouf 108 x 60 ó 98 x 60	219	232	241	250	259	201	2,2	0,19 0,17	14	1
42	Line pouf 88 x 60 ó 78 x 60	208	221	229	238	246	191	1,8	0,16 0,14	12	1
39	Line pouf de butaca 55 x 38	171	178	183	188	192	162	1,1	0,05	6,6	1
	Line brazo (incluye cojín decorativo)	121	127	131	135	139	113	1,7	0,05	5,8	1
	Line brazo siesta desenfundable	154	170	180	190	201	130	1,7	0,05	5,8	1
50	Line cojín 50 x 55 (relleno PLUS efecto plumón)	48	52	55	58	61	42	0,7	0,04	1,4	1

Baobab

Sofá fijo



Baobab mód. 105 (rincón) + mód. 78 + mód. 105 (rincón) + 3 cojines decorativos.

Estructura de madera de pino y tablero.
Suspensión con cincha elástica NEA.
100% desenfundable, con funda previa tapizada.
Posibilidad de comprar fundas extras.
Asiento, respaldo y brazos con relleno EXTRA CONFORT tipo sandwich: goma de 32 kg/m³ HR. + fibra reciclada ensacada efecto pluma.
Unión entre módulos oculta.
Pata negra inyectada de 3 cm.
Cojines decorativos NO incluidos.

Solid pine wood and fiber board structure.
NEA elastic webbing suspension.
100% removable covers, upholstered with fixed inner cover.
Possibility of buying extra covers.
Seat, backrest and armrests with EXTRA COMFORT using sandwich padding: 32 kg/m³ HR rubber. + recycled fiber filling.
Hidden connection between modules.
Black 3 cm. leg.
Loose pillows not included.



Structure et planche en bois de pin.
Suspension sangle élastique NEA.
100% déhoussable et avec revêtement rembourré.
Possibilité d'acheter des couvertures supplémentaires.
Assise, dossier et accoudoirs avec rembourrage sandwich EXTRA CONFORT: 32 kg/m³ de caoutchouc HR. + effet plume en fibre recyclée en sachet.
Union entre modules masquée.
Jambe noire injectée de 3cm.
Coussins décoratifs non inclus.

Funda exterior cosida y tapizada en fibra siliconada foamizada

Relleno efecto pluma, Fibra triafill ensacada en SRT (PET + algodón)

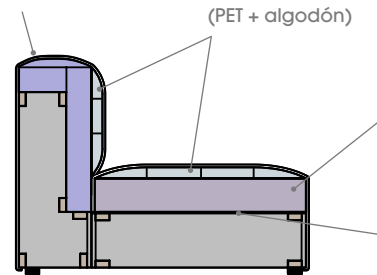

Asiento: Bloque de goma espuma de 32kg/m³ HR

Suspensión: Cincha elástica de 80mm. NEA, cubierta de capa de poliéster reciclado.





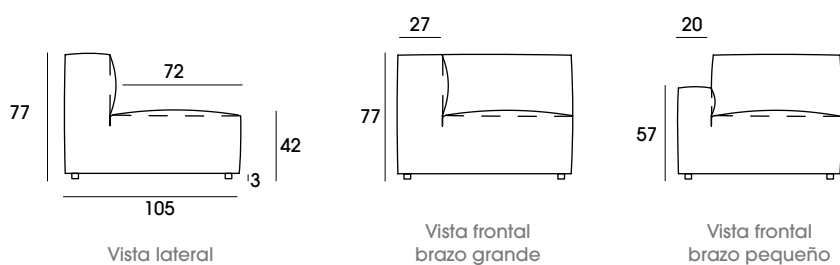

















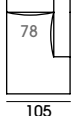
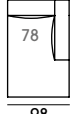

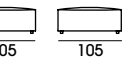
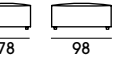
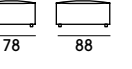
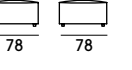







Baobab mód. 105 (rincón) + mód. 78 + mód. terminal de 142 cm. + 3 cojines decorativos.
Telas: Emily color 6 y Darven color 10



Baobab

Sofá fijo

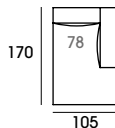
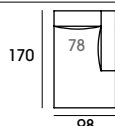
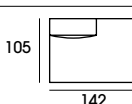
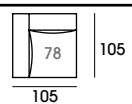
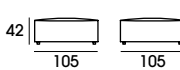
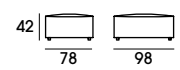
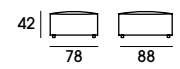
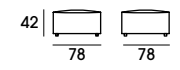
Medidas	Descripción	zero	SA	SB	SC	SD	TC				
	Baobab módulo 98 (sin brazo)	413	437	451	466	480	379	3,8	0,77	40	1
	Baobab módulo 88 (sin brazo)	395	418	431	445	459	363	3,6	0,69	37	1
	Baobab módulo 78 (sin brazo)	376	397	409	422	434	346	3,3	0,61	34	1
	Baobab módulo 125 (1 asiento de 98 con brazo grande de 27)	563	595	614	634	653	517	5,1	0,98	52	1
	Baobab módulo 115 (1 asiento de 88 con brazo grande de 27)	546	577	595	614	633	502	4,9	0,9	49	1
	Baobab módulo 105 (1 asiento de 78 con brazo grande de 27)	527	556	574	592	610	485	4,7	0,82	46	1
	Baobab módulo 118 (1 asiento de 98 con <u>brazo pequeño de 20</u>)	563	595	614	634	653	517	4,7	0,92	48,8	1
	Baobab módulo 108 (1 asiento de 88 con <u>brazo pequeño de 20</u>)	546	577	595	614	633	502	4,4	0,85	46,3	1
	Baobab módulo 98 (1 asiento de 78 con <u>brazo pequeño de 20</u>)	527	556	574	592	610	485	4,2	0,77	43,2	1
170 	Baobab chaise longue 105 (sentada de 78 con brazo grande de 27)	629	666	688	711	734	575	5,7	1,37	78	1
170 	Baobab chaise longue 98 (sentada de 78 con <u>brazo pequeño de 20</u>)	629	666	688	711	734	575	5,2	1,28	72,8	1
105 	Baobab terminal de 142	543	573	591	610	628	500	4,5	1,15	66	1
	Baobab rincón de 105	527	556	574	592	610	485	4,7	0,82	46	1
42 	Baobab pouf 105 x 105	321	343	357	370	384	289	3,4	0,46	33	1
42 	Baobab pouf 98 x 78	278	293	301	310	319	258	2,2	0,31	29	1
42 	Baobab pouf 88 x 78	267	280	288	296	304	248	2	0,28	25	1
42 	Baobab pouf 78 x 78	255	267	274	281	289	239	1,8	0,25	22	1
60 	Baobab cojín 60 x 60 (relleno PLUS efecto plumón)	48	52	55	58	61	42	1	0,05	2	1

Medidas	Descripción	zero	SA	SB	SC	SD	TC				
	Baobab FUNDA módulo 98 (sin brazo)	109	137	154	170	187	72	3,8	0,1	2	1
	Baobab FUNDA módulo 88 (sin brazo)	107	133	149	165	180	70	3,6	0,09	2	1
	Baobab FUNDA módulo 78 (sin brazo)	103	127	142	156	171	69	3,3	0,08	2	1
	Baobab FUNDA módulo 125 (1 asiento de 98 con brazo grande de 27)	139	176	198	221	243	87	5,1	0,15	2,5	1
	Baobab FUNDA módulo 115 (1 asiento de 88 con brazo grande de 27)	136	172	194	215	237	86	4,9	0,14	2,5	1
	Baobab FUNDA módulo 105 RINCÓN (1 asiento de 78 con brazo grande de 27)	134	168	189	209	230	85	4,7	0,13	2,5	1
	Baobab FUNDA módulo 118 (1 asiento de 98 con <u>brazo pequeño</u> de 20)	139	176	198	221	243	87	4,7	0,15	2	1
	Baobab FUNDA módulo 108 (1 asiento de 88 con <u>brazo pequeño</u> de 20)	136	172	194	215	237	86	4,4	0,14	2	1
	Baobab FUNDA módulo 98 (1 asiento de 78 con <u>brazo pequeño</u> de 20)	134	168	189	209	230	85	4,2	0,13	2	1
	Baobab FUNDA chaise longue 105 (sentada de 78 con brazo grande de 27)	163	205	230	255	280	105	5,7	0,15	3	1
	Baobab FUNDA chaise longue 98 (sentada de 78 con <u>brazo pequeño</u> de 20)	163	205	230	255	280	104	5,2	0,15	3	1
	Baobab FUNDA terminal de 142	132	165	185	206	226	84	4,5	0,13	3	1
	Baobab FUNDA rincón de 105	134	168	189	209	230	85	4,7	0,13	3	1
	Baobab FUNDA pouf 105 x 105	92	117	132	147	162	58	3,4	0,11	2	1
	Baobab FUNDA pouf 98 x 78	79	95	105	115	124	57	2,2	0,10	2	1
	Baobab FUNDA pouf 88 x 78	76	91	99	108	117	56	2	0,09	2	1
	Baobab FUNDA pouf 78 x 78	74	87	95	102	110	55	1,8	0,08	2	1
	Baobab FUNDA cojín 60 x 60	31	35	38	41	43	24	1	0,02	1	1

Zendo

Sofá fijo



Zendo mód. 116 con brazo + mesita Zendo baja + mód. 156 + mód. rincón + pouff 98x70



Zendo mód. 116 con brazo + mód. 156 + chaise longue 132



Zendo mód. 116 con brazo + pouff 102x102 + mód. 156 + chaise longue 132

Estructura de madera de pino y tablero.
Suspensión con cincha elástica NEA.
Asiento de goma de 30 kg/m³.
Respaldo y cojines rellenos con fibra de poliéster 100%.
Respaldos, asientos y cojines decorativos desenfundables.
Patas de madera de fresno maciza, con detalle metálico.
Patas metálicas opcionales.
La altura de la pata permite la limpieza con robot aspirador.

Solid pine wood and fiber board structure.
NEA webbing support for maximum comfort.
Loose cover seat cushion with 30 kg./m³ foam.
Loose cover back and decorative cushions with 100% polyester fiber filling.
Wood legs with mat black metal detail.
Metal legs optional.
The height of the legs allows for a robot vacuum cleaner to get under.

Structure en bois et DFM.
Suspension sangle élastique NEA.
Coussin de siège en caoutchouc de 30 kg/m³.
Coussins de dossier et coussins en fibre 100% polyester.
Dossiers, assises et coussins amovibles.
Pieds en frêne en option avec différentes finitions.
Pieds en métal en option.
La hauteur du pied permet le nettoyage avec un aspirateur robot.



Zendo

Sofá fijo

Mesas a juego, en madera de fresno.
Matching tables in ash wood.
Tables assorties en bois de frêne.

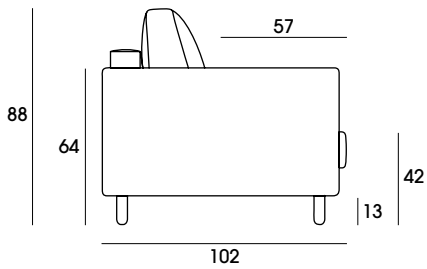

Medidas	Descripción	zero	SA	SB	SC	SD	TC				
 236	Zendo sofá 236 (3 asientos de 68)	783	845	899	961	1085	639	13	1,8	60	1
 228	Zendo sofá 228 (2 asientos de 98)	721	779	830	889	1006	585	12	1,74	58,8	1
 208	Zendo sofá 208 (2 asientos de 88)	696	752	800	856	967	567	11,5	1,59	54	1
 188	Zendo sofá 188 (2 asientos de 78)	671	724	770	822	927	550	11	1,44	49,2	1
 196	Zendo módulo 196 (2 asientos de 98)	626	673	713	759	852	518	10	1,5	46,8	1
 176	Zendo módulo 176 (2 asientos de 88)	597	640	678	721	808	496	9	1,35	42	1
 156	Zendo módulo 156 (2 asientos de 78)	570	610	646	686	767	476	8,5	1,19	37,2	1
 156	Zendo módulo 156 (1 asientos de 156)	550	588	621	659	734	462	8	1,19	37,2	1
 116	Zendo módulo 116 (sin brazo)	470	498	522	550	605	405	6	0,89	27,6	1
 98	Zendo módulo 98 (sin brazo)	428	454	577	504	556	367	5,5	0,75	23,4	1
 88	Zendo módulo 88 (sin brazo)	416	441	463	489	539	358	5,5	0,67	21	1
 78	Zendo módulo 78 (sin brazo)	405	429	450	474	523	348	5,5	0,6	18,6	1
153 132	Zendo chaise longue 132 (sentada de 116)	601	641	677	717	798	508	7,5	1,51	44	1
153 114	Zendo chaise longue 114 (sentada de 98)	575	613	647	686	762	486	7	1,31	38,5	1
102 102	Zendo módulo rincón 102 x 102	527	567	602	643	723	433	7,5	0,78	28	1

Incluye un cojín de 35 x 45 cm. por cada almohada de respaldo.
Includes one 35 x 45 cm. cushion for each back pillow.
Comprend un coussin 35 x 45 cm. pour chaque oreiller arrière.

Altura óptima para robot-aspirador.
Optimal height for robot vacuum cleaner.
Hauteur optimale pour robot aspirateur.



Medidas	Descripción	zero	SA	SB	SC	SD	TC				
46	Zendo Pouf 102 x 102	308	321	332	344	369	279	3,3	0,34	12	1
46	Zendo Pouf 116 x 70	283	296	307	319	344	254	3	0,27	9	1
46	Zendo Pouf 98 x 70	269	280	290	301	323	243	2,5	0,23	8,7	1
46	Zendo Pouf 88 x 70	258	268	277	287	308	235	2,5	0,2	7,8	1
46	Zendo Pouf 78 x 70	248	257	265	274	292	227	2,5	0,18	7	1
64	Zendo Brazo	74	82	90	98	114	56	2	0,08	2	1
35	Zendo Cojín 45 x 35	21	25	27	29	35	15	0,8	0,02	0,5	1
65	Zendo Mesa alta	385						-	0,19	11,2	1
42	Zendo Mesa baja	370						-	0,13	8,5	1

PW028
Madera Haya
Ash wood
Bois de frêne



PM012
Metal
Métal

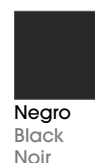
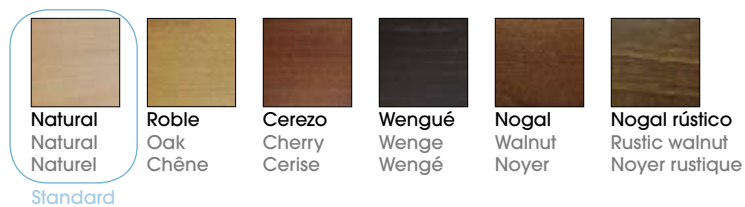

Colores disponibles también para las mesas ZENDO / Colors also available for ZENDO tables / Couleurs également disponibles pour les tables ZENDO.
Consultar para acabados especiales / Ask for special finishes / Consulter pour les finitions spéciales.

Krema

Sofá fijo



Krema sillón de 142 cm. con sentada de 98 cm.



Krema sofá de 240 cm. con dos sentadas de 98 cm.



Krema de 240 cm + Pouff de 98 x 70 cm.

Estructura de madera de pino y tablero.
Suspensión con cincha elástica NEA.
Asiento desenfundable relleno con goma de 30 kg/m³
y fibra de poliéster.
Respaldo y cojines decorativos desenfundables.
Rellenos con fibra de poliéster 100%.
Patas de madera con detalle metálico en negro mate.
Permite limpieza con robot aspirador.

Solid pine wood and fiber board structure.
NEA webbing support for maximum comfort.
Loose cover seat cushion with 30 kg/m³ foam
and polyester fiber filling.
Loose cover back and decorative cushions with
100% polyester fiber filling.
Wood legs with mat black metal detail.
The height of the legs allows for a robot vacuum
cleaner to get under.

Structure en bois et DFM.
Suspension sangle élastique NEA.
Assise déhoussable en mousse 30kg/m³ et fibre polyester.
Dossier et coussins deco déhoussables en fibre polyester 100%.
Pieds en bois avec détail métallique noir mate.
Permet le nettoyage avec un aspirateur robot.



Krema

Sofá fijo

Incluye un cojín de 40 x 55 cm. por cada almohada de respaldo.
Includes one 40 x 55 cm. cushion for each back pillow.
Comprend un coussin 40 x 55 cm. pour chaque oreiller arrière.

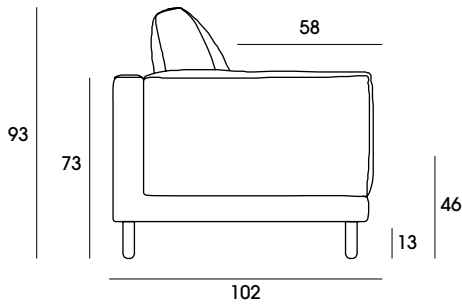

Altura óptima para robot-aspirador
Optimal height for robot vacuum cleaner
Hauteur optimale pour robot aspirateur



Medidas	Descripción	zero	SA	SB	SC	SD	TC				
 142	Krema sillón de 142 (1 asiento de 98)	576	610	638	672	739	499	9	1,16	38	1
 132	Krema sillón de 132 (1 asiento de 88)	557	587	616	648	709	484	8,5	1,08	35,5	1
 122	Krema sillón de 122 (1 asiento de 78)	539	569	593	623	683	469	8	0,99	33	1
 240	Krema sofá de 240 (2 sientos de 98)	856	907	950	1000	1102	738	13	1,96	66	1
 220	Krema sofá de 220 (2 sientos de 88)	809	858	899	946	1042	700	12,5	1,79	61	1
 200	Krema sofá de 200 (2 sientos de 78)	781	828	869	916	1008	672	12	1,63	56	1
 120	Krema módulo de 120 (1 asiento de 98 con 1 brazo)	503	529	554	580	634	439	7,5	0,98	33	1
 110	Krema módulo de 110 (1 asiento de 88 con 1 brazo)	475	501	524	548	601	417	7	0,9	30,5	1
 100	Krema módulo de 100 (1 asiento de 78 con 1 brazo)	456	480	501	526	572	402	6,5	0,82	28	1
 218	Krema módulo de 218 (2 asientos de 98 con 1 brazo)	777	822	863	908	998	672	12	1,33	60	1
 198	Krema módulo de 198 (2 asientos de 88 con 1 brazo)	738	781	818	860	946	640	11,5	1,21	55	1
 178	Krema módulo de 178 (2 asientos de 78 con 1 brazo)	676	715	749	788	867	584	11	1,09	50	1

PW028
Madera Haya
Ash wood
Bois de frêne



PM012
Metal
Métal

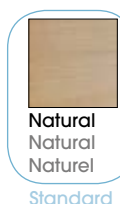

Standard

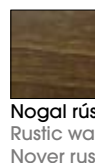
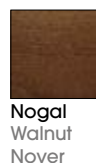
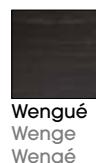
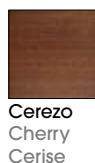
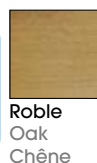

Consultar para acabados especiales / Ask for special finishes / Consulter pour les finitions spéciales.

Medidas	Descripción	zero	SA	SB	SC	SD	TC				
	Krema chaise longue de 120 (sentada de 98 con brazo, incluye 2 cojines decorativos)	599	633	663	696	764	520	7,9	1,5	53	1
	Krema chaise longue de 110 (sentada de 88 con brazo, incluye 2 cojines decorativos)	574	606	634	666	730	501	7,5	1,37	50,5	1
	Krema chaise longue de 100 (sentada de 78 con brazo, incluye 2 cojines decorativos)	542	572	599	629	691	471	7,1	1,25	48	1
	Krema rincón 102 x 102 (incluye 1 cojín decorativo)	494	524	550	582	644	420	7,5	0,83	33	1
	Krema terminal 130 (sentada de 98, incluye 1 cojín decorativo)	576	601	619	644	691	522	7,5	1,06	33	1
	Krema terminal 120 (sentada de 88, incluye 1 cojín decorativo)	539	563	582	606	653	484	7,5	0,98	30	1
	Krema terminal 110 (sentada de 78, incluye 1 cojín decorativo)	482	507	526	550	597	427	7,5	0,89	28	1
	Krema Pouf 98 x 70	278	289	298	310	332	242	3,8	0,22	10,5	1
	Krema Pouf 88 x 70	265	276	285	295	315	229	3,5	0,2	9,6	1
	Krema Pouf 78 x 70	252	261	268	278	297	240	3,5	0,18	8,8	1
	Krema cojín 55 x 40	21	25	27	29	35	15	0,8	0,03	0,6	1

Tribu

Sofá fijo



Tribu módulo 90 con brazo + 2 módulos de 90 + módulo de 90 con brazo.



Tribu mód. 90 con brazo + 2 mód. de 90 + rincón + módulo 90 + pouff de 90 + mód. 90 con brazo + pouff de 60 x 90 cm.



Estructura interna en madera de pino macizo.
Brazos y respaldo con estructura metálica
Suspensión con lamas **GOODSIDE** con 10 años de garantía.
Almohadas asiento de espuma 30 kg./m³.
Respaldo y cojines desenfundables con fibra de poliéster 100%.
Arcón de serie en todos los módulos.

Solid pine and fiber board structure.
Metal arms and back structure.
Slatted base seats with **GOODSIDE** 10 years guarantee.
Loose cover back and cushions with 100% polyester fiber filling.
Loose cover seat cushion with 30 Kg/m³ HR foam.
Storage in all modules as standard.

Structure interne en bois de pin massif.
Accoudoirs et dos avec structure en métal.
Suspension à lames **GOODSIDE** avec garantie de 10 ans.
Coussins d'assise en mousse 30 kg./m³.
Dossier et coussins en fibre 100% polyester.
Coffre standard dans tous les modules.
Oreillers amovibles.

Tribu

Sofá fijo



Incluye 1 cojín de 40 x 60 por cada respaldo + 1 cojín por brazo
 Includes 1 40 x 60 cushion for each backrest + 1 cushion per arm
 Comprend 1 coussin 40 x 60 pour chaque dossier + 1 coussin par bras

Todos los módulos son contenedor
 All modules are container
 Tous les modules sont des conteneurs

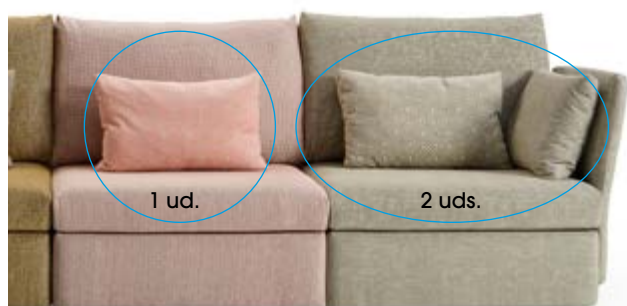

Medidas	Descripción	zero	SA	SB	SC	SD	TC				
	Tribu módulo 90 (sin brazo)	397	434	458	483	507	336	6,5	0,88	30	1
	Tribu módulo 100 (sentada de 90 con 1 brazo)	459	502	531	559	588	388	7	0,98	34,3	1
	Tribu rincón 100 x 100 (sentada de 90)	474	515	542	569	596	406	8,5	0,98	36	1
	Tribu módulo 75 sin brazo	355	381	399	416	434	310	5	0,73	25	1
	Tribu módulo 85 (sentada de 75 con 1 brazo)	426	466	493	520	547	358	6	0,83	30	1
	Tribu pouf 90 x 90	243	259	270	281	292	216	3	0,32	24,8	1
	Tribu Pouf 90 x 60	237	253	263	273	283	212	3	0,21	17	1
	Tribu Pouf 75 x 75	230	245	255	265	275	204	2,8	0,22	17,5	1
	Tribu cojín 60 x 40	21	25	27	29	35	15	0,8	0,02	0,7	1

Mirko

Sofá fijo



Mirko sofá de 218 cm. + pouff de 95 x 60 cm.

Estructura de madera de pino y tablero.
Suspensión con muelles metálicos.
Asiento relleno con goma de 30 kg/m³ HR.
Respaldo y cojines decorativos desenfundables.
Respaldo y cojines de fibra de poliéster 100%.
Patatas de madera de pino.

Structure in solid pine wood and fiber board.
Metallic springs suspension seats.
Seats with 30 Kg/m³ HR foam.
Loose cover backs and decorative cushions
with polyester fiber filling.
Wood legs.

Structure: bois pin + DMF.
Assise en ressorts.
Assise en mousse 30 kg/m³ HR.
Dossier et coussins deco déhoussables
Dossier et coussins en fibre polyester 100%.
Pieds en bois.



Mirko mód. 197 cm. + rincón + mód. 197 cm. + pouf de 95 x 60 cm.

Mirko

Sofá fijo



Incluye un cojín de 45x45 por cada brazo
 Includes a 45x45 cushion for each arm
 Comprend un coussin 45x45 pour chaque bras

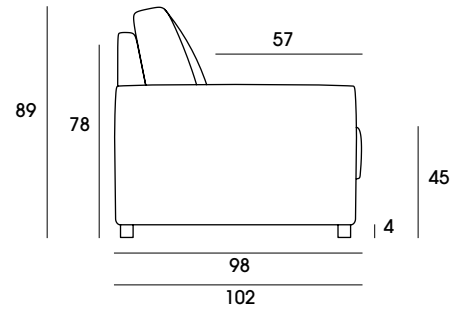

Medidas	Descripción	zero	SA	SB	SC	SD	TC				
 100	Mirko sillón 100 (sentada de 58)	433	477	506	546	623	347	6,5	0,82	27,2	1
 218	Mirko sofá 218 (2 asientos de 88)	667	729	770	823	933	549	12,2	1,8	58	1
 198	Mirko sofá 198 (2 asientos de 78)	625	683	722	773	876	513	10,6	1,64	52,8	1
 178	Mirko sofá 178 (2 asientos de 68)	604	660	696	746	844	498	10,2	1,47	47,6	1
 158	Mirko sofá 158 (2 asientos de 58)	582	635	671	719	814	477	9,6	1,4	42,4	1
 197	Mirko módulo de 197 (2 asientos de 88 con 1 brazo)	582	630	662	707	794	486	8,8	1,7	52	1
 177	Mirko módulo de 177 (2 asientos de 78 con 1 brazo)	537	583	614	655	736	450	8,2	1,5	46,8	1
 157	Mirko módulo de 157 (2 asientos de 68 con 1 brazo)	525	572	602	643	724	436	7,8	1,4	41,6	1
 137	Mirko módulo de 137 (2 asientos de 58 con 1 brazo)	501	544	575	613	691	416	7,3	1,2	36,4	1
 109	Mirko módulo de 109 (1 asiento de 88 con 1 brazo)	435	472	496	528	594	368	6,9	0,9	29	1
 99	Mirko módulo de 99 (1 asiento de 78 con 1 brazo)	411	443	465	496	556	346	5,9	0,8	26,4	1

Acabado de patas*

Leg finish / Finition des jambes

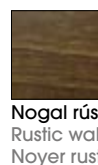
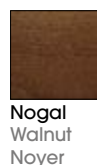
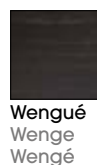
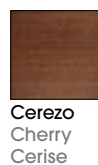
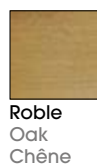

*Consultar para acabados especiales / Ask for special finishes / Consulter pour les finitions spéciales

Medidas	Descripción	zero	SA	SB	SC	SD	TC				
 89	Mirko módulo de 89 (1 asiento de 68 con 1 brazo)	394	431	455	488	553	323	5,4	0,73	23,8	1
 79	Mirko módulo de 79 (1 asiento de 58 con 1 brazo)	370	404	426	455	515	305	5	0,65	21,2	1
 88	Mirko módulo 88 (sin brazo)	330	352	368	387	428	286	5,5	0,73	23	1
 78	Mirko módulo 78 (sin brazo)	313	339	356	378	424	264	5,2	0,64	20,4	1
 68	Mirko módulo 68 (sin brazo)	289	311	327	347	387	246	5	0,56	17,8	1
 58	Mirko módulo 58 (sin brazo)	270	291	305	325	363	228	4,3	0,48	15,2	1
 78 160 99	Mirko chaise longue 99 (sentada de 78)	505	551	582	623	703	416	7,8	1,28	45	1
 68 160 89	Mirko chaise longue 89 (sentada de 68)	496	542	573	614	695	407	7	1,15	40	1
 103 103	Mirko rincón 103 x 103	428	457	476	503	554	371	5,2	0,86	29	1
 95 60 45	Mirko pouf 95 x 60	193	207	217	231	257	164	2,7	0,25	10,5	1
 45 45	Mirko cojín 45 x 45	21	25	27	29	35	15	0,7	0,02	0,6	1

Origen Capitoné

Sofá fijo



Origen capitoné de 300 cm. (3 asientos de 80 cm.) Tela velvet plus 25.

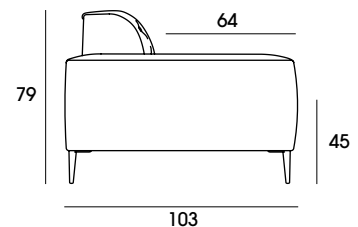

Estructura de madera de pino macizo.
Asiento desenfundable en goma de 30 Kg/m³.
Suspensión de muelle metálico en zig-zag.
Patas metálicas en negro mate.
Brazo librería opcional con diferentes acabados.
Incluye un cojín de 50 x 50, por asiento.
Permite limpieza con robor aspirador.

Solid pine wood structure.
Removable 30 Kg/m³ foam seat.
Zig-zag metal spring suspension.
Metallic matt black legs.
Optional bookcase arm with different finishes.
Includes a 50 x 50 cushion, per seat.
Allows cleaning with a vacuum cleaner.

Structure en pin.
Assise amovible en caoutchouc 30Kg/m³.
Suspension à ressort métallique en zigzag.
Pieds noirs mats métallisés.
Bras de bibliothèque en option avec différentes finitions.
Comprend un coussin 50 x 50, par siège.
Permet le nettoyage avec un aspirateur.

Origen Capitoné

Sofá fijo



Pata de serie/
Standard

PM004
Metal



15 cm.



Negro
Black / Noir



Altura óptima para robot-aspirador.
Optimal height for robot vacuum cleaner.
Hauteur optimale pour robot aspirateur.

Medidas	Descripción	zero	SA	SB	SC	SD	TC				
	Origen sofá 300 (3 asientos de 80)	1499	1606	1665	1729	1792	1419	11	2,04	127	2
	Origen sofá 270 (3 asientos de 70)	1419	1526	1587	1650	1712	1340	10,5	1,83	119	2
	Origen sofá 240 (3 asientos de 60)	1340	1445	1508	1571	1632	1260	9,5	1,63	111	2
	Origen sofá 220 (2 asientos de 80)	1232	1340	1401	1464	1526	1153	8,6	1,49	103	2
	Origen sofá 200 (2 asientos de 70)	1179	1286	1349	1410	1473	1099	8	1,36	95	2
	Origen sofá 180 (2 asientos de 60)	1126	1232	1295	1356	1419	1046	7,6	1,22	90	1
	Origen Capitoné puf de 120 x 60	585	601	617	634	657	554	4,9	0,25	25	1
	Origen cojín 50 x 50	21	25	27	29	35	15	0,8	0,02	0,7	1
	Incremento librería (por cada brazo)						80				

Flamingo

Sofá deslizable

Flamingo



Flamingo de 294 cm. (2 deslizantes de 78 cm. + chaise longue de 108 cm.)
Tela Romeo color marengo.



Estructura en madera de pino y tablero.
Mecanismo deslizable con pata al suelo.
Suspensión con cincha elástica Nea.
Asiento en goma de 33 kg./m³S.
Cabezal multiposición.
Almohadas de fibra desenfundables.
Brazo almohada con arcón de serie.
Patas metálicas negro mate.

Structure in solid pine wood and fiber board.
Sliding mechanism with foot on the ground.
NEA elastic webbing suspension.
33kg./m³ S. foam seat.
Multi position headrest.
Backrest and armrest in fiber filling.
Storage arm 30 cm. as standard.
Matt black metal legs.

Structure en bois de pin et planche.
Mécanisme coulissant avec pied au sol.
Suspension avec sangle élastique Nea.
Siège en caoutchouc 33 kg/m³ S.
Tête multi-positions.
Oreillers amovibles en fibres.
Bras d'oreiller avec poitrine en standard.
Pieds en métal noir mat.

Flamingo

Sofá deslizable

Flamingo



Brazo-contenedor de serie
Standard container arm
Bras de conteneur standard

Cabezal
multiposición

Pata de serie/
Standard

PM016
Metal



12 cm.



Negro
Black / Noir

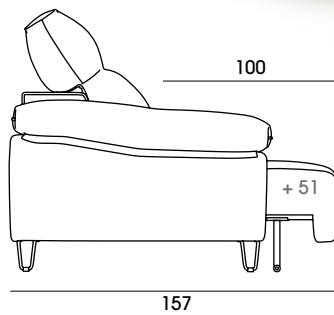
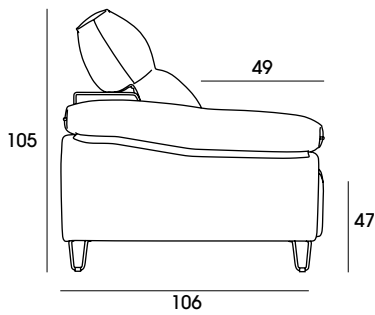





Altura óptima para robot-aspirador.
Optimal height for robot vacuum cleaner.
Hauteur optimale pour robot aspirateur.









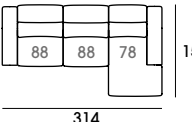
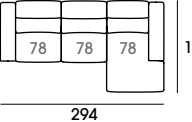
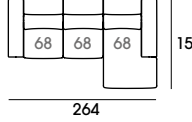
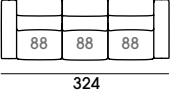
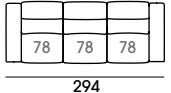
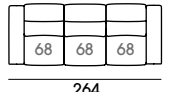
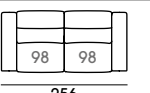
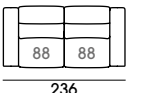
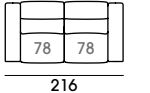
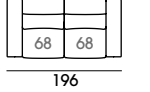
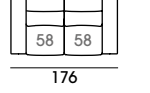
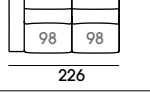
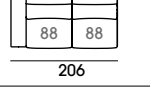
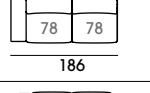
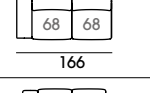
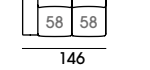













Flamingo

Sofá deslizante

Flamingo

Medidas	Descripción	zero	SA	SB	SC	SD	TC				
	Flamingo chaise longue 314 (2 deslizantes de 88 con chaise de 108)	1150	1214	1273	1331	1447	1041	17	3,5	110	2
	Flamingo chaise longue 294 (2 deslizantes de 78 con chaise de 108)	1077	1161	1235	1294	1412	999	15,8	3,31	103,1	2
	Flamingo chaise longue 264 (2 deslizantes de 68 con chaise de 98)	1052	1116	1174	1232	1347	942	15,5	2,99	92,7	2
	Flamingo sofá 324 (3 deslizantes de 88)	1161	1243	1288	1347	1467	1049	16,2	3,08	92,4	2
	Flamingo sofá 294 (3 deslizantes de 78)	1074	1151	1208	1266	1381	978	15,4	2,8	84	2
	Flamingo sofá 264 (3 deslizantes de 68)	1028	1103	1159	1215	1327	935	15	2,52	75,5	2
	Flamingo sofá 256 (2 deslizantes de 98)	926	987	1033	1078	1168	854	12	2,42	74,8	2
	Flamingo sofá 236 (2 deslizantes de 88)	831	889	932	975	1061	761	11,5	2,25	70,6	1
	Flamingo sofá 216 (2 deslizantes de 78)	790	845	886	927	1010	722	11	2,06	68	1
	Flamingo sofá 196 (2 deslizantes de 68)	734	786	824	863	940	670	10,3	1,88	66,3	1
	Flamingo sofá 176 (2 deslizantes de 58)	707	757	794	830	903	647	9,8	1,69	63,7	1
	Flamingo módulo deslizante de 226 (2 deslizantes de 98 con 1 brazo)	811	864	904	944	1022	748	10,5	2,1	70,6	2
	Flamingo módulo deslizante de 206 (2 deslizantes de 88 con 1 brazo)	732	771	807	843	914	655	9,5	1,95	65,6	1
	Flamingo módulo deslizante de 186 (2 deslizantes de 78 con 1 brazo)	682	728	762	796	864	626	9,1	1,6	63	1
	Flamingo módulo deslizante de 166 (2 deslizantes de 68 con 1 brazo)	646	683	708	742	808	575	8,9	1,58	61,3	1
	Flamingo módulo deslizante de 146 (2 deslizantes de 58 con 1 brazo)	607	650	683	715	780	553	8,7	1,39	58,7	1

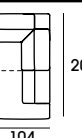
Medidas	Descripción	zero	SA	SB	SC	SD	TC				
	Flamingo módulo deslizante de 128 (1 deslizante de 98 con 1 brazo)	474	505	528	550	595	438	6	1,3	38,7	1
	Flamingo módulo deslizante de 118 (1 deslizante de 88 con 1 brazo)	434	473	494	515	556	412	5,5	1,13	33,8	1
	Flamingo módulo deslizante de 108 (1 deslizante de 78 con 1 brazo)	422	450	471	491	531	390	5,4	1,03	31	1
	Flamingo módulo deslizante de 98 (1 deslizante de 68 con 1 brazo)	408	435	455	475	514	376	5,3	0,94	28,2	1
	Flamingo módulo deslizante de 88 (1 deslizante de 58 con 1 brazo)	371	397	417	436	475	339	5,2	0,84	25,4	1
	Flamingo módulo deslizante de 98 (sin brazo)	380	405	424	443	480	350	5	0,98	29,8	1
	Flamingo módulo deslizante de 88 (sin brazo)	355	379	398	416	451	326	4,8	0,83	24,8	1
	Flamingo módulo deslizante de 78 (sin brazo)	332	356	373	390	424	304	4,6	0,73	22	1
	Flamingo módulo deslizante de 68 (sin brazo)	322	344	361	378	412	294	4,5	0,64	19,1	1
	Flamingo módulo deslizante de 58 (sin brazo)	310	332	348	365	397	282	4,4	0,54	16,3	1
	Flamingo chaise longue 108 (sentada de 78)	429	455	472	494	540	381	6	1,55	50,1	1
	Flamingo chaise longue 98 (sentada de 68)	425	450	468	491	537	376	6	1,41	45,3	1
	Flamingo rincón 110 x 110	442	476	498	528	588	379	8	1,03	34	1
	Flamingo terminal cabezal 108 (sentada de 78)	386	425	444	470	523	340	7	0,93	23,5	1
	Flamingo terminal cabezal 98 (sentada de 68)	381	415	439	465	518	335	7	0,85	20	1
	Flamingo terminal cabezal 88 (sentada de 58)	376	410	435	461	513	330	7	0,76	16,5	1
	Flamingo rincón - chaise longue	602	642	669	704	775	527	9,5	2,18	56	1
Incremento brazos reducidos de más de -5cm. (no lleva arcón)		37									

*Brazo reducido de -5 cm. misma tarifa y mantiene el arcón.

Flow

Sofá deslizante



Sofá Flow de 284 (2 deslizantes de 120). Tela Channel 2.

Estructura en madera de pino y tablero.
Mecanismo deslizante con pata al suelo.
Suspensión con muelle metálico.
Asiento en goma de 30kg./m³ S.
Cabezal de goma mltiposición.
Brazo recto y deslizante de 25 cm. de serie.
Brazo almohada opcional, con arcón y deslizante.
Almohadas desenfundables.
Patas metálicas negro mate.

Structure in solid pine wood and fiber board.
Sliding mechanism with foot on the ground.
Metal spring suspension.
30kg./m³ S. foam seat.
Multi position headrest.
Straight and sliding arm of 25 cm. as standard.
Pillow arm, with storage box and slider, as option.
Loose covers.
Matt black metal legs.

Structure en bois de pin et métal laqué
époxy, démontable.
Mécanisme coulissant avec pied au sol.
Suspension à ressort métallique.
Siège en caoutchouc 30kg./m³ S.
Tête en caoutchouc multi-positions.
Bras droit et coulissant de 25 cm. en série.
Bras d'oreiller en option, avec coffre et
 curseur.
Oreillers amovibles.
Pieds en métal noir mat.

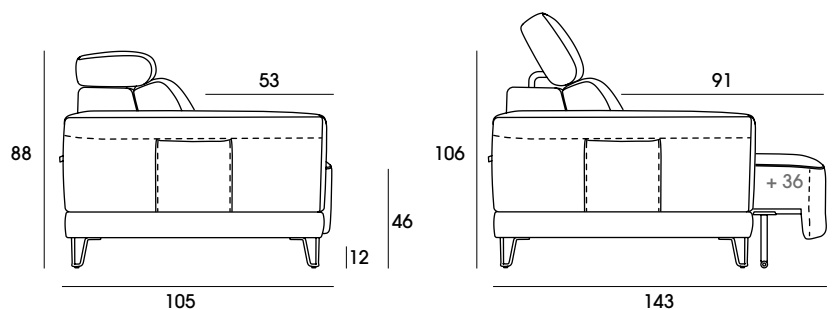

Flow

Sofá deslizable

FLOW



Sofá con rincón chaise longue Flow de 298
(Rincón chaiselongue + 2 deslizantes de 80). Tela Lenon 8205

Incluye un cojín de 50 x 50 cm. por brazo.
Includes a 50 x 50 cm cushion, per arm.
Comprend un coussin de 50 x 50 cm. par bras.



Pata de serie/
Standard

PM013
Metal



12 cm.



Negro
Black / Noir

Altura óptima para robot-aspirador.
Optimal height for robot vacuum cleaner.
Hauteur optimale pour robot aspirateur.























12 cm.

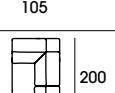
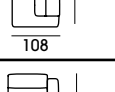
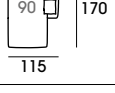
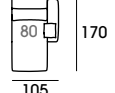

Flow

Sofá deslizante

Medidas	Descripción	zero	SA	SB	SC	SD	TC				
 320	Flow sofá 320 (3 deslizantes de 90)	1323	1429	1489	1550	1610	1217	16,1	2,55	138,7	2
 290	Flow sofá 290 (3 deslizantes de 80)	1285	1383	1439	1495	1550	1187	14,9	2,31	124,9	2
 260	Flow sofá 260 (3 deslizantes de 70)	1248	1340	1392	1444	1496	1157	13,9	2,07	111,1	2
 290	Flow sofá 290 (2 deslizantes de 120)	1046	1138	1190	1242	1294	955	13,9	2,31	125,6	2
 270	Flow sofá 270 (2 deslizantes de 110)	1023	1110	1160	1210	1260	935	13,3	2,15	116,4	2
 250	Flow sofá 250 (2 deslizantes de 100)	998	1081	1128	1175	1223	915	12,6	1,99	107,2	2
 230	Flow sofá 230 (2 deslizantes de 90)	937	1015	1060	1105	1151	858	12	1,83	97,8	2
 210	Flow sofá 210 (2 deslizantes de 80)	911	985	1027	1069	1111	837	11,2	1,67	88,6	1
 190	Flow sofá 190 (2 deslizantes de 70)	886	955	995	1034	1074	817	10,5	1,51	79,4	1
 265	Flow módulo deslizante de 265 (2 deslizantes de 120 con 1 brazo)	946	1025	1070	1115	1160	867	12	2,11	117,6	2
 245	Flow módulo deslizante de 245 (2 deslizantes de 110 con 1 brazo)	922	997	1040	1083	1125	847	11,4	1,95	108,4	2
 225	Flow módulo deslizante de 225 (2 deslizantes de 100 con 1 brazo)	899	971	1012	1053	1093	828	10,9	1,79	99,2	2
 205	Flow módulo deslizante de 205 (2 deslizantes de 90 con 1 brazo)	838	905	944	983	1021	770	10,3	1,63	89,8	2
 185	Flow módulo deslizante de 185 (2 deslizantes de 80 con 1 brazo)	813	876	912	948	984	750	9,6	1,47	80,6	1
 165	Flow módulo deslizante de 165 (2 deslizantes de 70 con 1 brazo)	788	847	880	914	947	730	8,9	1,31	71,4	1

Medidas	Descripción	zero	SA	SB	SC	SD	TC				
 145	Flow módulo deslizante de 145 (1 deslizante de 120 con 1 brazo)	524	570	596	622	648	478	7	1,15	62,8	1
 135	Flow módulo deslizante de 135 (1 deslizante de 110 con 1 brazo)	512	556	581	606	631	468	6,7	1,07	58,2	1
 125	Flow módulo deslizante de 125 (1 deslizante de 100 con 1 brazo)	500	542	566	590	614	458	6,4	0,99	53,6	1
 115	Flow módulo deslizante de 115 (1 deslizante de 90 con 1 brazo)	487	526	549	572	594	448	6	0,91	48,9	1
 105	Flow módulo deslizante de 105 (1 deslizante de 80 con 1 brazo)	475	513	534	555	577	438	5,7	0,83	44,3	1
 95	Flow módulo deslizante de 95 (1 deslizante de 70 con 1 brazo)	463	499	519	539	559	428	5,4	0,75	39,7	1
 120	Flow módulo deslizante de 120 (sin brazo)	422	455	474	493	511	389	5	0,95	54,8	1
 110	Flow módulo deslizante de 110 (sin brazo)	410	441	459	477	495	380	4,7	0,87	50,2	1
 100	Flow módulo deslizante de 100 (sin brazo)	398	427	444	460	477	370	4,4	0,79	45,6	1
 90	Flow módulo deslizante de 90 (sin brazo)	386	412	427	442	457	359	4	0,71	40,9	1
 80	Flow módulo deslizante de 80 (sin brazo)	374	398	412	426	440	349	3,7	0,63	36,3	1
 70	Flow módulo deslizante de 70 (sin brazo)	362	384	397	410	422	340	3,4	0,55	31,7	1
 105	Flow rincón	450	486	507	527	548	414	5,5	0,83	42	1
 200	Flow rincón chaislongue	714	773	807	841	875	655	9	1,68	56	1
 170	Flow chaislongue 115 (sentada de 90) Incluye 1 cojín decorativo	499	545	571	596	622	454	6,9	1,48	56	1
 170	Flow chaislongue 105 (sentada de 80) Incluye 1 cojín decorativo	480	524	550	575	601	435	6,8	1,35	52	1
	Flow brazo recto de 25 cm. Incluye cojín de 50 x 50. (Deslizante SIN ARCÓN)*	101	114	122	130	137	88	2	0,15	8	1
	Flow brazo almohada de 25 cm. (Deslizante CON ARCÓN)*	101	114	122	130	137	88	3	0,16	9	1
 50	Cojín 50 x 50	21	25	27	29	35	15	0,7	0,02	0,8	1

*Brazo reducido de -5 cm. sólo posible en el brazo recto. No tiene incremento de precio pero pierde el deslizante.

Snoopy

Sofá deslizante



Snoopy sofá de 298 cm. con pata metálica.

Cabezal
tipo italiano



Snoopy chaise longue de 298 cm. con pata de madera natural.

Estructura en madera de pino macizo.
Mecanismo deslizante con pata al suelo.
Suspensión con muelle metálico y cincha.
Asiento en goma biodegradable 35kg./m³.
Riñonera de goma de 23kg./m³ SS.
Cabezal de goma con multiposición.
Brazo contenedor de 32 cm., de serie.
Almohadas desenfundables.
Patas metálicas negro mate, de serie.
Patas de madera opcionales.

Solid pine wood structure.
Sliding mechanism with leg on the ground.
Suspension with metal spring and strap.
35kg./m³ biodegradable foam seat.
23kg./m³ SS foam lower back cushion.
Multi position headrest.
Storage arm 32cm. as standard.
Loose covers.
Matt black metal legs, as standard.
Optional wooden legs.

Structure interne en bois de pin massif.
Mécanisme coulissant avec pieds au sol.
Suspension avec ressort métallique et sangle.
Siège en caoutchouc biodégradable 35 kg./m³.
Sac ceinture en caoutchouc de 23 kg/m³ SS.
Tête en caoutchouc multi-positions.
Standard bras de conteneur de 32 cm.
Oreillers amovibles.
Pieds en métal noir mat de série.
Pieds en bois en option.

Snoopy

Sofá deslizable

Snoopy



Snoopy chaise longue de 298 con pata metálica.

Brazo-contenedor de serie
Standard container arm
Bras de conteneur standard



PW030
Madera
Wood / Bois



13,5 cm.

Acabado de patas*
Leg finish / Finition des jambes



Natural
Natural
Naturel



Roble
Oak
Chêne



Cerezo
Cherry
Cerise



Wengué
Wenge
Wengé



Nogal
Walnut
Noyer



Nogal rústico
Rustic walnut
Noyer rustique

Pata de serie/
Standard

PM007
Metal



13,5 cm.

Acabado de patas
Leg finish / Finition des jambes



Negro
Black
Noir

*Consultar para acabados especiales / Ask for special finishes / Consulter pour les finitions spéciales

*Pata de madera sin incremento / Wood leg without increment / Pieds en bois optionnels sans incrément.

Snoopy

Sofá deslizante

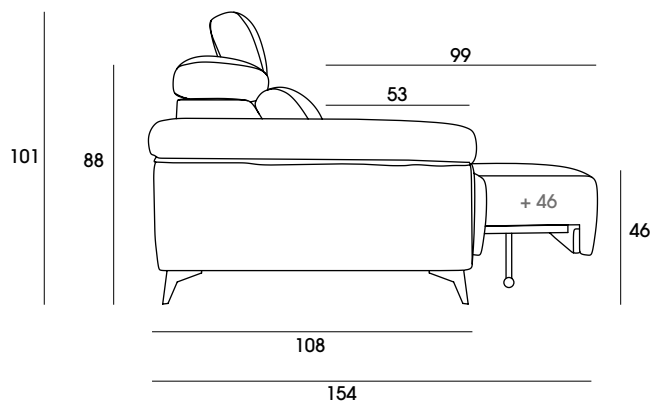

Altura óptima para robot-aspirador.
Optimal height for robot vacuum cleaner.
Hauteur optimale pour robot aspirateur.



Snoopy

Medidas	Descripción	zero	SA	SB	SC	SD	TC				
	Snoopy composición chaise longue 318 (2 deslizantes de 88 + chaise de 110)	1361	1495	1573	1651	1730	1223	16,8	2,92	110	3
	Snoopy composición chaise longue 298 (2 deslizantes de 78 + chaise de 110)	1253	1402	1486	1571	1656	1091	15,4	2,76	103,1	2
	Snoopy composición chaise longue 268 (2 deslizantes de 68 + chaise de 100)	1191	1329	1409	1488	1567	1043	15,1	2,5	92,7	2
	Snoopy composición chaise longue 248 (2 deslizantes de 58 + chaise de 100)	1169	1302	1379	1454	1530	1026	15	2,4	85,8	2
	Snoopy sofá 328 (3 deslizantes de 88)	1375	1511	1587	1666	1746	1236	16	2,61	92,4	3
	Snoopy sofá 298 (3 deslizantes de 78)	1248	1394	1475	1558	1641	1091	14,8	2,37	84	2
	Snoopy sofá 268 (3 deslizantes de 68)	1184	1317	1394	1470	1545	1043	14,5	2,13	75,5	2
	Snoopy sofá 238 (3 deslizantes de 58)	1116	1217	1276	1334	1392	1011	14,3	1,89	67,1	2
	Snoopy sofá 240 (2 deslizantes de 88)	1014	1142	1208	1280	1352	876	13	1,91	67,7	2
	Snoopy sofá 220 (2 deslizantes de 78)	976	1094	1158	1224	1290	850	11,4	1,75	62	2
	Snoopy sofá 200 (2 deslizantes de 68)	938	1046	1108	1168	1228	824	10,1	1,59	53,6	1
	Snoopy sofá 180 (2 deslizantes de 58)	846	900	932	964	996	794	8,9	1,43	45,1	1

Medidas	Descripción	zero	SA	SB	SC	SD	TC				
 208	Snoopy módulo de 208 (2 deslizantes de 88 con 1 brazo)	868	940	983	1026	1070	798	10,8	1,65	58,6	2
 188	Snoopy módulo de 188 (2 deslizantes de 78 con 1 brazo)	760	847	896	946	996	666	9	1,39	53	1
 168	Snoopy módulo de 168 (2 deslizantes de 68 con 1 brazo)	715	794	840	886	931	631	8,8	1,34	47,3	1
 148	Snoopy módulo de 148 (2 deslizantes de 58 con 1 brazo)	693	767	810	852	894	614	8,7	1,17	41,7	1
 120	Snoopy módulo 120 (1 deslizante de 88 con 1 brazo)	507	571	604	640	676	438	6,5	0,95	33,8	1
 110	Snoopy módulo 110 (1 deslizante de 78 con 1 brazo)	488	547	579	612	645	425	5,8	0,87	31	1
 100	Snoopy módulo 100 (1 deslizante de 68 con 1 brazo)	469	523	554	584	614	412	5,7	0,79	28,2	1
 90	Snoopy módulo 90 (1 deslizante de 58 con 1 brazo)	423	450	466	482	498	397	5,7	0,71	25,4	1
 88	Snoopy módulo deslizante de 88 (sin brazo)	378	412	432	452	472	346	5	0,7	24,8	1
 78	Snoopy módulo deslizante de 78 (sin brazo)	361	397	419	440	461	321	4,2	0,62	22	1
 68	Snoopy módulo deslizante de 68 (sin brazo)	343	375	393	411	430	311	4,1	0,54	19,1	1
 58	Snoopy módulo deslizante de 58 (sin brazo)	326	356	372	389	405	296	4	0,46	16,3	1
 110	Snoopy rincón 110 x 110	476	510	538	572	638	405	6,9	0,83	34	1
 110	Snoopy chaise longue 110 (sentada de 78)	493	555	590	625	660	425	6,7	1,34	50,1	1
 100	Snoopy chaise longue 100 (sentada de 68)	476	535	569	602	636	412	6,6	1,21	45,3	1

*Misma tarifa para brazo reducido de -5 cm. (mantiene el arcón).

Goofy

Sofá deslizante

Goofy



Goofy composición chaise longue de 298 con pata metálica.

Cabezal
multiposición



Goofy composición chaise longue de 298 con pata de madera natural.

Estructura en madera de pino macizo.
Mecanismo deslizante con pata al suelo.
Suspensión con muelle metálico y cincha.
Asiento en goma biodegradable 35kg./m³.
Riñonera de fibra hueca siliconada.
Cabezal de fibra con multiposición.
Brazo contenedor de 32 cm., de serie.
Almohadas desenfundables.
Patas metálicas negro mate de serie.
Patas de madera opcionales.

Solid pine wood structure.
Sliding mechanism with leg on the ground.
Suspension with metal spring and strap.
35kg/m³ biodegradable foam seat.
Lower back cushion in hollow silicone fiber.
Multi position headrest.
Storage arm 32cm as standard.
Loose covers.
Matt black metal legs.
Optional wooden legs.

Structure interne en bois de pin massif.
Mécanisme coulissant avec pieds au sol.
Suspension avec ressort métallique et sangle.
Siège en caoutchouc biodégradable 35kg./m³.
Sac ceinture en fibre creuse en silicone.
Tête en fibre avec multi-positions.
Standard bras de conteneur de 32 cm.
Oreillers amovibles.
Pieds en métal noir mat de série.
Pieds en bois en option.



Goofy composición chaise longue de 298 con pata metálica.

Brazo-contenedor de serie
Standard container arm
Bras de conteneur standard



PW030
Madera
Wood / Bois



13,5 cm.

Acabado de patas*
Leg finish / Finition des jambes



Natural
Natural
Naturel



Roble
Oak
Chêne



Cerezo
Cherry
Cerise



Wengué
Wenge
Wengé



Nogal
Walnut
Noyer



Nogal rústico
Rustic walnut
Noyer rustique

Pata de serie/
Standard

PM007
Metal



13,5 cm.

Acabado de patas
Leg finish / Finition des jambes



Negro
Black
Noir

*Consultar para acabados especiales / Ask for special finishes / Consulter pour les finitions spéciales

*Pata de madera sin incremento / Wood leg without increment / Pieds en bois optionnels sans incrément.

Goofy



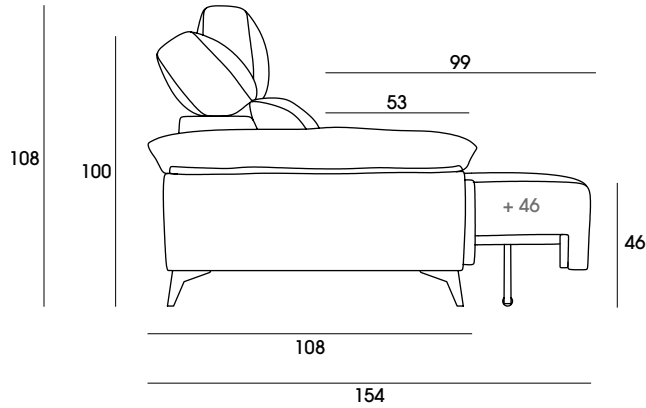







Sofá deslizante

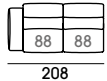
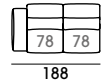
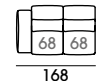
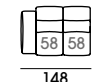
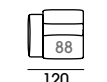
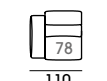

Altura óptima para robot-aspirador.
Optimal height for robot vacuum cleaner.
Hauteur optimale pour robot aspirateur.

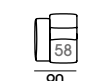
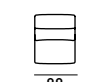

Medidas	Descripción	zero	SA	SB	SC	SD	TC				
 154 318	Goofy composición chaise longue 318 (2 deslizantes de 88 + chaise de 110)	1272	1403	1481	1558	1636	1138	17	3,5	110	3
 154 298	Goofy composición chaise longue 298 (2 deslizantes de 78 + chaise de 110)	1172	1312	1391	1471	1551	1021	15,8	3,31	103,1	2
 154 268	Goofy composición chaise longue 268 (2 deslizantes de 68 + chaise de 100)	1115	1245	1321	1398	1473	977	15,5	2,99	92,7	2
 154 248	Goofy composición chaise longue 248 (2 deslizantes de 58 + chaise de 100)	1095	1219	1290	1362	1532	961	15,3	2,8	85,8	2
 328	Goofy sofá 328 (3 deslizantes de 88)	1284	1416	1493	1572	1650	1149	16	3,08	92,4	3
 298	Goofy sofá 298 (3 deslizantes de 78)	1167	1304	1380	1459	1536	1021	15	2,8	84	2
 268	Goofy sofá 268 (3 deslizantes de 68)	1108	1234	1307	1381	1453	977	14,7	2,52	75,5	2
 238	Goofy sofá 238 (3 deslizantes de 58)	1044	1139	1194	1248	1402	947	14,5	2,23	67,1	2
 240	Goofy sofá 240 (2 deslizantes de 88)	946	1064	1128	1198	1266	816	13,5	2,25	67,7	2
 220	Goofy sofá 220 (2 deslizantes de 78)	912	1022	1082	1146	1208	794	11,6	2,06	62	2
 200	Goofy sofá 200 (2 deslizantes de 68)	878	980	1036	1094	1150	772	11,3	1,88	53,6	1
 180	Goofy sofá 180 (2 deslizantes de 58)	790	842	872	900	930	744	9,4	1,69	45,1	1

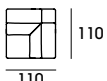
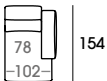
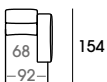
Medidas	Descripción	zero	SA	SB	SC	SD	TC				
 208	Goofy módulo de 208 (2 deslizantes de 88 con 1 brazo)	811	884	929	973	1017	741	11	1,95	58,6	2
 188	Goofy módulo de 188 (2 deslizantes de 78 con 1 brazo)	711	793	839	886	932	624	9	1,6	53	1
 168	Goofy módulo de 168 (2 deslizantes de 68 con 1 brazo)	669	744	789	834	878	591	8,8	1,58	47,3	1
 148	Goofy módulo de 148 (2 deslizantes de 58 con 1 brazo)	649	718	758	798	937	575	8,7	1,39	41,7	1
 120	Goofy módulo 120 (1 deslizante de 88 con 1 brazo)	473	532	564	599	633	408	7	1,13	33,8	1
 110	Goofy módulo 110 (1 deslizante de 78 con 1 brazo)	456	511	541	573	604	397	6	1,03	31	1
 100	Goofy módulo 100 (1 deslizante de 68 con 1 brazo)	439	490	518	547	575	386	5,9	0,94	28,2	1
 90	Goofy módulo 90 (1 deslizante de 58 con 1 brazo)	395	421	436	450	465	372	5,8	0,84	25,4	1
 88	Goofy módulo deslizante de 88 (sin brazo)	354	391	413	435	457	319	5,5	0,83	24,8	1
 78	Goofy módulo deslizante de 78 (sin brazo)	337	372	391	411	432	301	4,2	0,73	22	1
 68	Goofy módulo deslizante de 68 (sin brazo)	321	350	368	385	402	291	4	0,64	19,1	1
 58	Goofy módulo deslizante de 58 (sin brazo)	305	332	347	364	379	276	3,9	0,54	16,3	1
 110	Goofy rincón 110 x 110	446	476	504	534	580	379	7,3	0,96	34	1
 110	Goofy chaise longue 110 (sentada de 78)	461	519	552	585	619	397	6,9	1,55	50,1	1
 100	Goofy chaise longue 100 (sentada de 68)	446	501	532	564	595	386	6,8	1,41	45,3	1

*Misma tarifa para brazo reducido de -5 cm. (mantiene el arcón).

Ilana

Sofá deslizante

Ilana



Ilana sofá 254 cm. (2 asientos de 98 cm.)

Estructura de madera de pino y tablero.
Suspensión con cincha elástica NEA (excepto en la sentada de 98 que va con malla electrosoldada).
Asiento con de goma de 40 kg/m³.
Mecanismo deslizante con pata al suelo.
Brazo deslizante con arcón de serie.
Cabezal multiposición.
Almohadas desenfundables.
Asiento chaiselonge no desenfundable.
Patas metálicas color cromo.

Brazo-contenedor de serie
Standard container arm
Bras de conteneur standard

Structure in solid pine wood and fiber board.
NEA elastic webbing suspension (except in the 98 seat that goes with electro-welded mesh).
40 kg./m³ foam seat cushion.
Sliding mechanism with support leg.
Sliding arm with storage as standard.
Multi-position headrest.
Removable covers on back cushions. Chaise longue seat cover is NOT removable. Chrome metal legs.

Structure en bois de pin et DMF.
Suspension sangle élastique NEA (sauf dans le siège 98 qui va avec treillis électrosoudé).
Siège avec 40 kg/m³ de caoutchouc.
Mécanisme coulissant avec pied au sol.
Bras coulissant avec boîte de rangement en standard.
Tête multi-positions.
Oreillers amovibles.
Siège chaise longue non amovible.
Pieds en métal couleur cromo.



Ilana

Sofá deslizable

Ilana



Ilana sofá de 262 cm. (3 asientos de 68 cm.)



Ilana sofá de 262 cm. (3 asientos de 68 cm.)

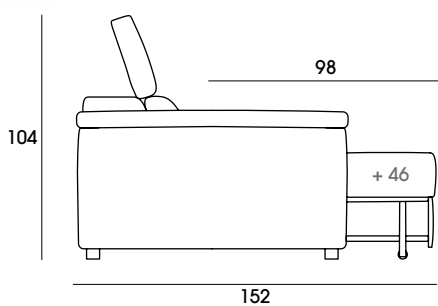
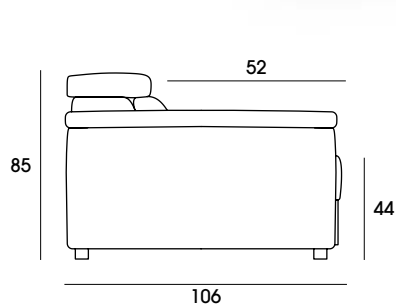

Pata de serie/
Standard

PM009
Metal







Cromo









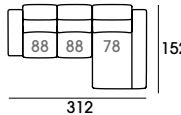
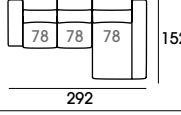
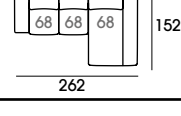
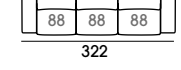
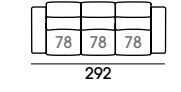
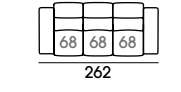
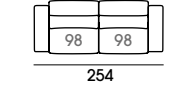
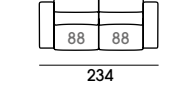
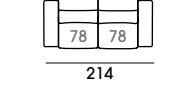
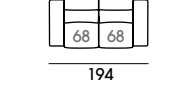
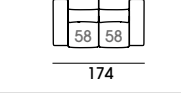
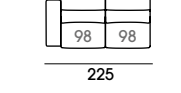
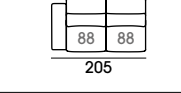
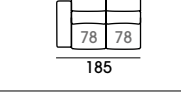
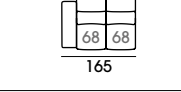
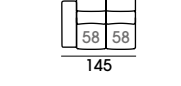











Ilana

Sofá deslizante

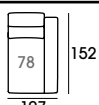
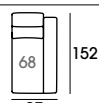
Ilana

Medidas	Descripción	serie oferta*	zero	SA	SB	SC	SD	TC				
	Ilana chaise longue 312 (2 deslizantes 88 + chaise de 107)	1106	1160	1244	1318	1403	1571	980	17,5	3,4	123	2
	Ilana chaise longue 292 (2 deslizantes 78 + chaise de 107)	1032	1082	1161	1231	1311	1469	913	16,8	3,18	115	2
	Ilana chaise longue 262 (2 deslizantes 68 + chaise de 97)	1018	1068	1145	1213	1291	1447	910	15,4	2,85	103,7	2
	Ilana sofá 322 (3 deslizantes de 88)	1153	1204	1285	1356	1437	1598	1032	16,5	3,06	112,5	2
	Ilana sofá 292 (3 deslizantes de 78)	1052	1097	1170	1235	1308	1455	941	15,5	2,78	100,5	2
	Ilana sofá 262 (3 deslizantes de 68)	1038	1083	1155	1217	1289	1433	939	14,2	2,49	90	2
	Ilana sofá 254 (2 deslizantes de 98)	945	984	1045	1102	1164	1289	852	13,2	2,42	92,2	2
	Ilana sofá 234 (2 deslizantes de 88)	830	867	927	979	1038	1157	741	12,2	2,23	85	1
	Ilana sofá 214 (2 deslizantes de 78)	776	810	865	913	968	1078	694	11,6	2,03	77	1
	Ilana sofá 194 (2 deslizantes de 68)	756	790	843	890	943	1049	676	10,9	1,85	70	1
	Ilana sofá 174 (2 deslizantes de 58)	736	768	819	864	915	1018	659	10,2	1,66	63	1
	Ilana módulo de 225 (2 deslizantes de 98 con 1 brazo)	900	934	986	1032	1086	1191	821	11,2	2,14	77,5	1
	Ilana módulo de 205 (2 deslizantes de 88 con 1 brazo)	704	736	786	830	880	980	629	10,2	1,95	70	1
	Ilana módulo de 185 (2 deslizantes de 78 con 1 brazo)	630	658	703	743	788	878	562	9,5	1,76	62	1
	Ilana módulo de 165 (2 deslizantes de 68 con 1 brazo)	627	655	699	737	781	870	569	8,7	1,57	55	1
	Ilana módulo de 145 (2 deslizantes de 58 con 1 brazo)	610	636	678	715	757	841	547	8	1,38	48	1

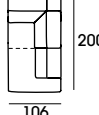
Medidas	Descripción	serie oferta*	zero	SA	SB	SC	SD	TC				
	Ilana módulo 127 (1 deslizante de 98 con 1 brazo)	487	507	538	565	597	659	440	6,5	1,2	46,1	1
	Ilana módulo 117 (1 deslizante de 88 con 1 brazo)	449	468	499	526	557	618	403	6,4	1,11	42,5	1
	Ilana módulo 107 (1 deslizante de 78 con 1 brazo)	422	439	467	492	520	577	379	6	0,92	38,5	1
	Ilana módulo 97 (1 deslizante de 68 con 1 brazo)	411	428	456	480	508	563	370	5,6	1,02	35	1
	Ilana módulo 87 (1 deslizante de 58 con 1 brazo)	405	422	449	473	500	554	365	5,2	0,83	31,5	1
	Ilana módulo deslizante de 98 (sin brazo)	413	427	448	467	489	532	381	4,5	0,93	31,1	1
	Ilana módulo deslizante de 88 (sin brazo)	332	345	365	383	404	445	302	4,4	0,84	27,5	1
	Ilana módulo deslizante de 78 (sin brazo)	305	317	336	354	373	412	276	4	0,74	23,5	1
	Ilana módulo deslizante de 68 (sin brazo)	294	306	325	341	360	398	265	3,6	0,65	20	1
	Ilana módulo deslizante de 58 (sin brazo)	287	298	316	332	350	386	260	3,3	0,55	16,5	1
	Ilana chaise longue de 107 (sentada de 78)	402	424	458	488	523	591	351	7,3	1,42	53	1
	Ilana chaise longue de 97 (sentada de 68)	391	413	446	476	510	577	341	7	1,28	48,7	1
	Ilana terminal cabezal de 104 (asiento de 78)	332	348	373	396	421	472	294	5,2	0,93	23,5	1
	Ilana terminal cabezal de 94 (asiento de 68)	324	339	364	386	410	459	287	5	0,85	20	1
	Ilana terminal cabezal de 84 (asiento de 58)	317	331	355	375	399	446	281	4,9	0,76	16,5	1
	Ilana rincón 110 x 110	429	450	484	513	547	615	378	6,7	1,03	34	1
	Ilana rincón chaise longue	624	654	688	719	753	822	581	9,4	1,66	48	1
Brazo reducido de -5 cm. (mantiene el arcón y el deslizante)		sin incremento										
Incremento brazos reducidos de más de -5cm. (no lleva arcón ni deslizante)		37 (por sofá)										
Incremento chaise longue arcón		64										

*Serie oferta: Tela Rado y Lido.

Milano

Sofá deslizante

Milano



Milano sofá de 220 cm. (2 deslizantes de 78 cm.) Tela Alexander rosa.



Milano composición chaise longue de 298 cm.
Tela Alexander rosa.

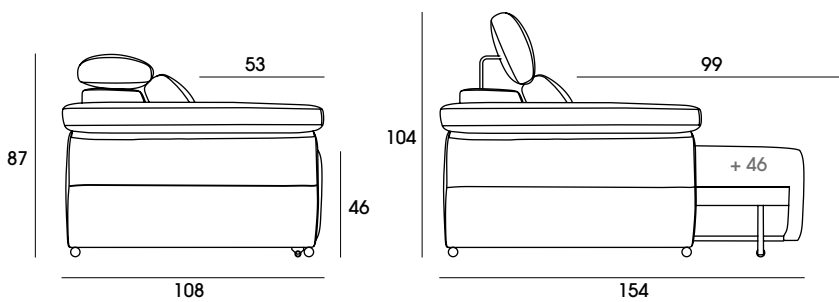

Pata de serie/
Standard

PM009
Metal



Cromo

Milano

Sofá deslizable

Milano

Cabezal
tipo italiano



Milano composición chaise longue de 298 cm.

Estructura de madera de pino y tablero.
Suspensión con bastidor metálico y cinchas.
Mecanismo deslizable con pata al suelo.
Asiento con de goma de 40 kg/m³.
Respaldo y brazo con goma de 25 kg/m³ suave.
Almohadas desenfundables.
Brazo deslizable con arcón de serie.
Brazo reducido de 27 cm. opcional (mismo precio).
Patas metálicas color cromo.

Brazo deslizable y contenedor de serie
Sliding arm and container as standard
Bras coulissant et conteneur de série

Structure in solid pine wood and board.
Suspension with metal frame and straps.
Sliding mechanism with leg to the ground.
40 kg./m³ rubber seat cushion.
Backrest and arm with soft 25 kg/m³ rubber.
Removable pillows.
Sliding arm with storage box as standard.
27 cm. optional reduced arm (same price).
Metal legs in cromo colour.





Structure en bois de pin et DMF.
Suspension avec cadre et sangles en métal.
Glissière en métal avec support de roue au sol.
Siège avec 40 kg/m³ de caoutchouc.
Dos et bras en caoutchouc de 25 kg/m³.
Oreillers amovibles.
Bras coulissant avec boîte de rangement.
Bras réduit de 27 cm. en option (même prix).
Pieds en métal de couleur cromo.









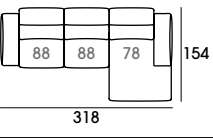
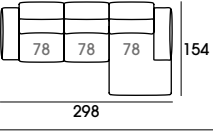
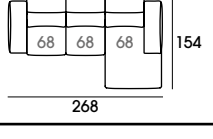
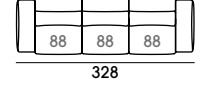
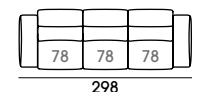
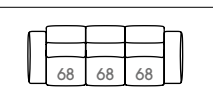
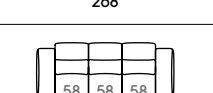
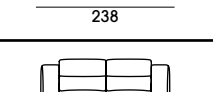
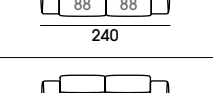
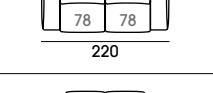
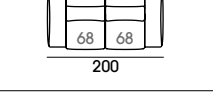
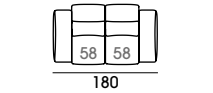
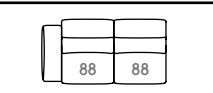
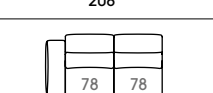
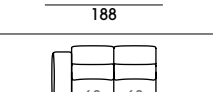





Milano

Sofá deslizante

Milano

Medidas	Descripción	zero	SA	SB	SC	SD	TC				
	Milano chaise longue 318 (2 deslizantes de 88 con chaise de 110)	1258	1405	1488	1572	1656	1099	18,7	3,5	122,5	2
	Milano chaise longue 298 (2 deslizantes de 78 con chaise de 110)	1234	1381	1464	1548	1632	1075	17,9	3,32	117,2	2
	Milano chaise longue 268 (2 deslizantes de 68 con chaise de 100)	1174	1310	1388	1466	1544	1028	17,5	2,99	105,8	2
	Milano sofá 328 (3 deslizantes de 88)	1277	1421	1501	1583	1665	1123	17,7	3,08	114,7	2
	Milano sofá 298 (3 deslizantes de 78)	1223	1351	1424	1497	1571	1087	16,9	2,8	102,7	2
	Milano sofá 268 (3 deslizantes de 68)	1176	1299	1368	1438	1508	1048	16,5	2,52	92,2	2
	Milano sofá 238 (3 deslizantes de 58)	1161	1281	1350	1418	1487	1035	16,3	2,24	80,3	2
	Milano sofá 240 (2 deslizantes de 88)	1008	1124	1188	1254	1320	884	14,2	2,25	87,2	2
	Milano sofá 220 (2 deslizantes de 78)	960	1076	1140	1206	1272	836	13,5	2,06	79,2	2
	Milano sofá 200 (2 deslizantes de 68)	924	1030	1090	1150	1210	812	13,4	1,88	72,2	1
	Milano sofá 180 (2 deslizantes de 58)	832	886	918	948	980	782	12,9	1,69	65,2	1
	Milano módulo de 208 (2 deslizantes de 88 con 1 brazo)	773	859	907	956	1005	681	12,8	1,95	72,1	1
	Milano módulo de 188 (2 deslizantes de 78 con 1 brazo)	749	835	883	932	981	657	11,2	1,76	64,2	1
	Milano módulo de 168 (2 deslizantes de 68 con 1 brazo)	705	783	828	872	917	622	10,2	1,58	57,3	1
	Milano módulo de 148 (2 deslizantes de 58 con 1 brazo)	683	756	798	840	881	605	9,6	1,39	50,1	1

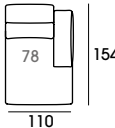
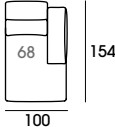
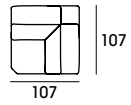
Medidas	Descripción	zero	SA	SB	SC	SD	TC				
	Milano módulo de 120 (1 deslizante de 88 con 1 brazo)	504	562	594	627	660	442	8	1,13	42,5	1
	Milano módulo de 110 (1 deslizante de 78 con 1 brazo)	480	538	570	603	636	418	7,5	1,03	39,6	1
	Milano módulo de 100 (1 deslizante de 68 con 1 brazo)	462	515	545	575	605	406	6,9	0,94	36,1	1
	Milano módulo de 90 (1 deslizante de 58 con 1 brazo)	416	443	459	474	490	391	6,6	0,84	31,5	1
	Milano módulo deslizante de 88 (sin brazo)	379	415	436	457	478	340	5,5	0,83	27,5	1
	Milano módulo deslizante de 78 (sin brazo)	355	391	412	433	454	316	4,8	0,73	23,5	1
	Milano módulo deslizante de 68 (sin brazo)	338	369	387	405	423	306	4,1	0,64	20	1
	Milano módulo deslizante de 58 (sin brazo)	321	350	366	383	399	291	3,8	0,54	16,5	1
	Milano chaise longue 110 (sentada de 78)	485	546	581	616	651	418	8	1,55	55	1
	Milano chaise longue 100 (sentada de 68)	469	527	560	594	627	406	6,9	1,41	49,2	1
	Milano rincón 107 x 107	469	502	530	563	629	399	6,7	0,99	34	1
	Brazo reducido de -5 cm. (mantiene el arcón y el deslizante)	sin incremento									
	Incremento brazos reducidos de más de -5cm. (no lleva arcón ni deslizante)	37 (por sofá)									

Cosmo

Sofá deslizante



Cosmo sofá de 208 cm. (2 asientos de 78 cm.)



Cosmo chaise longue de 286 cm. (2 asientos de 78 + chaise de 78)

Cosmo

Sofá deslizante

Estructura de madera de pino y tablero.
 Suspensión con cincha elástica NEA.
 Mecanismo deslizante con pata al suelo.
 Asiento con de goma de 40 kg/m³.
 Respaldo y brazo con goma de 25 kg/m³ suave.
 Almohadas desenfundables.
 Brazo con arcón de serie.
 Brazo reducido opcional (21 cm. sin arcón)
 Patas metálicas color cromo.

Structure in solid pine wood and fiber board.
 Suspension with NEA elastic straps.
 Sliding mechanism with leg to the ground.
 40 kg./m³ foam seat cushion.
 Backrest and arm with soft 25 kg/m³ foam.
 Removable covers.
 Arm with storage box as standard.
 Optional reduced arm (21 cm. without storage)
 Metal legs in cromo colour.

Structure en bois de pin et DMF.
 Suspension sangle élastique NEA.
 Glissière en métal avec support de roue au sol.
 Siège avec 40 kg/m³ de caoutchouc.
 Dos et bras en caoutchouc de 25 kg/m³.
 Oreillers amovibles.
 Bras avec boîte de rangement.
 Bras réduit en option (21 cm. sans conteneur).
 Pieds en métal de couleur cromo.

Brazo-contenedor de serie
 Standard container arm
 Bras de conteneur standard



Cosmo



Cabezal tipo italiano

Pata de serie/
 Standard

PM009
 Metal





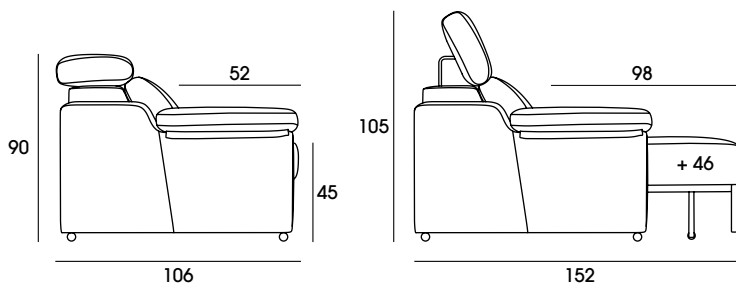









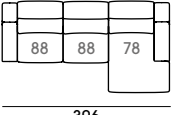
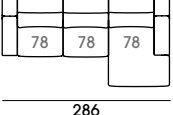
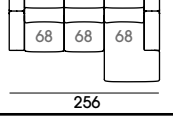
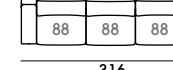
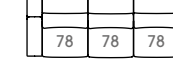
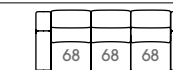
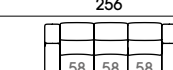
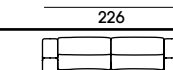
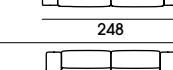
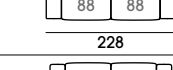
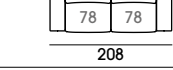
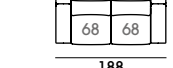
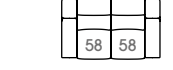

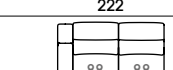
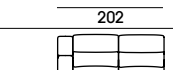







Cromo



Cosmo

Sofá deslizante

Medidas	Descripción	zero	SA	SB	SC	SD	TC				
 152 306	Cosmo chaise longue 306 (2 deslizantes de 88 con chaise de 104)	1194	1262	1320	1388	1524	1049	19,6	3,9	104	2
 152 286	Cosmo chaise longue 286 (2 deslizantes de 78 con chaise de 104)	1069	1147	1215	1293	1450	902	18,5	3,72	97	2
 152 256	Cosmo chaise longue 256 (2 deslizantes de 68 con chaise de 94)	1044	1123	1193	1272	1430	876	18	3,34	88	2
 316	Cosmo sofá 316 (3 deslizantes de 88)	1207	1263	1312	1369	1482	1086	19,2	2,97	96	2
 286	Cosmo sofá 286 (3 deslizantes de 78)	1054	1130	1198	1274	1428	891	18	2,72	90	2
 256	Cosmo sofá 256 (3 deslizantes de 68)	1038	1114	1181	1258	1411	874	17	2,44	82,5	2
 226	Cosmo sofá 226 (3 deslizantes de 58)	1023	1096	1162	1235	1383	865	15,8	2,51	74,7	1
 248	Cosmo sofá 248 (2 deslizantes de 98)	968	1017	1057	1106	1199	875	13,2	2,8	78	2
 228	Cosmo sofá 228 (2 deslizantes de 88)	835	876	912	953	1034	748	12,8	2,56	74	1
 208	Cosmo sofá 208 (2 deslizantes de 78)	739	794	843	898	1009	621	12	2,31	70	1
 188	Cosmo sofá 188 (2 deslizantes de 68)	728	782	830	884	993	612	11,5	2,09	65	1
 168	Cosmo sofá 168 (2 deslizantes de 58)	718	772	818	872	979	605	11,2	1,87	59,8	1
 222	Cosmo módulo 222 (2 deslizantes de 98 con 1 brazo)	878	921	956	997	1079	796	12,5	2,4	61	
 202	Cosmo módulo 202 (2 deslizantes de 88 con 1 brazo)	763	798	828	863	933	688	11,8	2,22	58	
 182	Cosmo módulo 182 (2 deslizantes de 78 con 1 brazo)	638	683	723	768	859	541	11	2,02	55	1
 162	Cosmo módulo 162 (2 deslizantes de 68 con 1 brazo)	627	673	714	760	853	528	10,5	1,8	50	1
 142	Cosmo módulo 142 (2 deslizantes de 58 con 1 brazo)	619	663	703	747	837	523	9,5	1,58	44,8	1

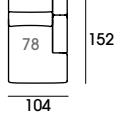
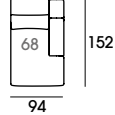
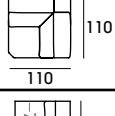
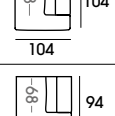
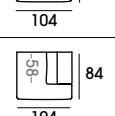
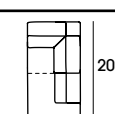
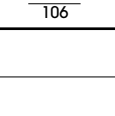
Medidas	Descripción	zero	SA	SB	SC	SD	TC				
	Cosmo módulo 124 (1 deslizante de 98 con 1 brazo)	484	509	530	553	601	438	7,8	1,18	41	1
	Cosmo módulo 114 (1 deslizante de 88 con 1 brazo)	444	465	484	506	549	398	7,4	1,08	38,1	1
	Cosmo módulo 104 (1 deslizante de 78 con 1 brazo)	416	447	475	506	569	350	7	0,99	35	1
	Cosmo módulo 94 (1 deslizante de 68 con 1 brazo)	411	441	467	498	558	346	6,5	0,89	32,5	1
	Cosmo módulo 84 (1 deslizante de 58 con 1 brazo)	404	433	459	488	546	342	6,3	0,8	29,9	1
	Cosmo módulo deslizante de 98 (sin brazo)	394	411	427	443	479	357	5,2	0,93	26	1
	Cosmo módulo deslizante de 88 (sin brazo)	355	371	385	400	431	322	5	0,84	23,1	1
	Cosmo módulo deslizante de 78 (sin brazo)	321	341	359	379	419	278	4,8	0,74	20	1
	Cosmo módulo deslizante de 68 (sin brazo)	316	335	352	371	410	276	4,5	0,65	17,5	1
	Cosmo módulo deslizante de 58 (sin brazo)	309	328	344	363	400	270	4	0,55	14,9	1
	Cosmo chaise longue 104 (sentada de 78)	431	464	492	525	591	361	7,8	1,46	45	1
	Cosmo chaise longue 94 (sentada de 68)	417	450	479	512	577	348	7,5	1,32	38	1
	Cosmo rincón 110 x 110	469	502	530	563	629	399	8	1,09	34	1
	Cosmo terminal cabezal 104 (sentada de 78)	353	377	399	423	471	302	5,8	0,97	36	1
	Cosmo terminal cabezal 94 (sentada de 68)	347	370	391	414	460	298	5,5	0,88	32,5	1
	Cosmo terminal cabezal 84 (sentada de 58)	343	365	385	408	453	295	5	0,78	29	1
	Cosmo rincón chaise longue	654	688	719	753	822	581	9,4	1,9	48	1
	Incremento chaise longue arcón	64									
	Brazo medida especial (por sofá)	37									

Lémur

Sofá motorizado

Lémur



Lémur sofá de 304 cm. (3 asientos motorizados de 88 cm.). Tela Gloria 753.

Estructura de madera de pino y tablero.
Suspensión de muelles metálicos zig-zag.
Mecanismo de apertura motorizada.
Asiento con de goma de 35 kg./m³ Soja.
Cabezales articulados.
Botonera exterior con puerto USB, de serie.
Pata alta metálica negro mate.

Structure in solid pine wood and fiber board.
Metallic spring suspension.
Motorized opening mechanism.
35 kg./m³ Soya foam seat.
Articulated heads.
Button panel with USB charging port.
High matte black metallic legs.

Structure en bois de pin et DMF.
Suspension à ressort métallique.
Mécanisme d'ouverture motorisé.
Siège avec 35 kg./m³ de caoutchouc soja.
Têtes articulées.
Clavier externe avec port USB, en standard.
Pieds hauts en métal noir mat.



Lémur

Sofá motorizado



Lémur

Cabezal
multiposición



Lémur sofá de 304 cm. (3 asientos motorizados de 88 cm.). Tela Gloria 753.

Lémur

Sofá motorizado

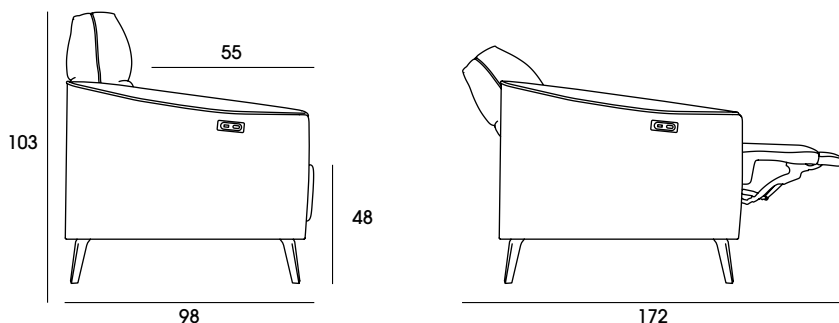

Pata de serie/
Standard

PM015
Metal



















15 cm.

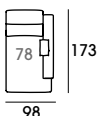
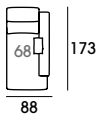

Negro
Black / Noir

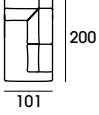
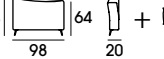
Medidas	Descripción	zero	SA	SB	SC	SD	TC				
	Lémur chaise longue 294 (2 motorizados de 88 con chaise de 98)	1550	1626	1676	1743	1878	1407	17	3,76	145	3
	Lémur chaise longue 274 (2 motorizados de 78 con chaise de 98)	1508	1579	1626	1690	1816	1374	16	3,54	141	3
	Lémur chaise longue 244 (2 motorizados de 68 con chaise de 88)	1445	1513	1558	1619	1740	1316	15,3	3,16	133	3
	Lémur sofá 304 (3 motorizados de 88)	1663	1736	1784	1848	1977	1526	16,3	3,06	147,8	3
	Lémur sofá 274 (3 motorizados de 78)	1587	1656	1702	1763	1886	1457	15,5	2,76	141,8	3
	Lémur sofá 244 (3 motorizados de 68)	1558	1624	1669	1728	1847	1432	15	2,46	135,8	3
	Lémur sofá 236 (2 motorizados de 98)	1249	1306	1344	1394	1495	1142	12,8	2,38	115	2
	Lémur sofá 216 (2 motorizados de 88)	1203	1256	1292	1339	1434	1102	12	2,18	103	2
	Lémur sofá 296 (2 motorizados de 78)	1143	1194	1228	1273	1363	1048	11,4	1,97	99,2	2
	Lémur sofá 176 (2 motorizados de 68)	1122	1171	1204	1247	1334	1030	11	1,77	95,2	2

Medidas	Descripción	zero	SA	SB	SC	SD	TC				
	Lémur módulo de 98 MOTORIZADO (sin brazo)	518	539	552	570	607	480	4,6	0,98	49,8	1
	Lémur módulo de 88 MOTORIZADO (sin brazo)	491	509	522	539	572	456	4,2	0,88	44,6	1
	Lémur módulo de 78 MOTORIZADO (sin brazo)	475	492	503	518	548	443	3,8	0,78	42,6	1
	Lémur módulo de 68 MOTORIZADO (sin brazo)	465	481	492	506	535	435	3,6	0,68	40,6	1
	Lémur módulo de 98 FIJO (sin brazo)	347	368	383	402	441	306	4,9	0,98	43,8	1
	Lémur módulo de 88 FIJO (sin brazo)	320	340	353	370	405	283	4,4	0,88	39,6	1
	Lémur módulo de 78 FIJO (sin brazo)	307	326	339	355	388	272	4,2	0,78	37,6	1
	Lémur módulo de 68 FIJO (sin brazo)	298	316	327	343	375	264	4	0,68	35,6	1
	Lémur chaise longue de 98 (sentada de 78)	509	541	563	592	650	448	7,3	1,74	48,8	1
	Lémur chaise longue de 88 (sentada de 68)	487	519	539	567	622	429	7	1,56	44,8	1
	Lémur rincón 110 x 110	511	542	563	590	646	452	7	1,24	38	1
	Lémur terminal cabezal (1 asiento de 78)	425	452	469	493	541	375	6	1,1	30	1
	Lémur rincón - chaise longue	692	734	762	799	875	612	9,5	2,08	55	1
	Lémur brazo de 20 cm. + cojín decorativo	111	120	126	134	149	94	2	0,14	7	1
	Lémur cojín decorativo 34 x 47	21	25	27	29	35	15	0,6	0,02	0,6	1

Tucán

Sofá motorizado



Tucán sofá de 232 cm. (2 asientos de 88 cm.). Pata PW029 de madera natural.
Tela Gaucho color 2.



Estructura de madera de pino y tablero.
Suspensión de muelles metálicos.
Mecanismo de apertura motorizada.
Asiento con de goma de 40 kg./m³.
Cabezal multiposición.
Almohadas desenfundables.
Asiento chaise longue no desenfundable.
Botonera con puerto USB, de serie.
Patas metálicas color grafito.
Patas opcionales de haya maciza.

Structure in solid pine wood and fiber board.
Metallic spring suspension.
Motorized opening mechanism.
40 kg./m³ foam seat.
Multi-position headrest.
Removable covers.
Chaiselonge seat cover not removable.
Button panel with USB charging port.
Metallic graphite coloured legs.
Optional beech legs.

Structure en bois de pin et DMF.
Suspension à ressort métallique.
Mécanisme d'ouverture motorisé.
Siège en caoutchouc de 40 kg./m³.
Tête multi-positions.
Oreillers amovibles.
Siège de chaise longue non amovible.
Panneau de boutons avec port de chargement USB.
Pieds de couleur graphite métallique.
Pieds en option en hêtre massif.

Tucán

Sofá motorizado

Tucán



Tucán chaise longue de 290 cm. (2 asientos de 78 + chaise de 78).
Pata PM006. Tela Gaucho color 3.



Cabezal tipo italiano

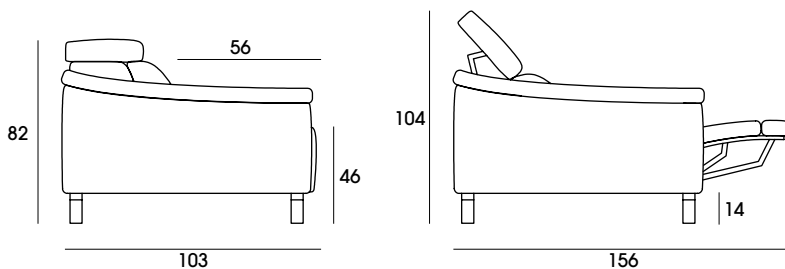

Botonera con USB incluida
Keypad with USB included
Clavier avec USB inclus



Tucán

Sofá motorizado

PW029
Madera Haya
Ash wood
Bois de frêne

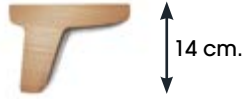

Pata de serie/
Standard

PM006
Metal



Natural
Natural
Naturel



Roble
Oak
Chêne



Cerezo
Cherry
Cerise



Wengué
Wenge
Wengé



Nogal
Walnut
Noyer

















Nogal rústico
Rustic walnut
Noyer rustique



Grafito
Graphite

Consultar para acabados especiales / Ask for special finishes / Consulter pour les finitions spéciales.

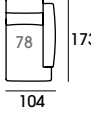
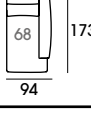
Medidas	Descripción	zero	SA	SB	SC	SD	TC				
	Tucán chaise longue 306 (2 motorizados de 88 con chaise de 104)	1639	1722	1795	1878	2044	1462	18	2,67	154,6	3
	Tucán chaise longue 286 (2 motorizados de 78 con chaise de 104)	1582	1663	1733	1814	1975	1411	17,5	2,53	143,4	3
	Tucán chaise longue 256 (2 motorizados de 68 con chaise de 94)	1552	1630	1699	1778	1935	1385	17	2,14	125,9	3
	Tucán chaise longue 236 (2 motorizados de 58 con chaise de 94)	1524	1601	1669	1747	1902	1359	16,5	2	114,7	3
	Tucán sofá 316 (3 motorizados de 88)	1751	1835	1908	1991	2153	1582	17	2,24	162,2	3
	Tucán sofá 286 (3 motorizados de 78)	1669	1747	1815	1893	2049	1503	16,5	2,03	145,4	3
	Tucán sofá 256 (3 motorizados de 68)	1642	1719	1786	1862	2015	1479	16	1,82	128,6	3
	Tucán sofá 226 (3 motorizados de 58)	1599	1674	1739	1813	1963	1441	15,5	1,61	111,8	3
	Tucán sofá 228 (2 motorizados de 88)	1265	1328	1383	1444	1564	1141	13,5	1,62	112,8	2
	Tucán sofá 208 (2 motorizados de 78)	1211	1270	1321	1380	1496	1087	13	1,48	101,6	2
	Tucán sofá 188 (2 motorizados de 68)	1194	1251	1301	1359	1474	1072	12,5	1,34	90,4	2
	Tucán sofá 168 (2 motorizados de 58)	1166	1222	1272	1328	1441	1046	12	1,2	79,2	2

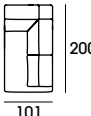
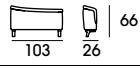
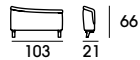
Medidas	Descripción	zero	SA	SB	SC	SD	TC				
 88	Tucán módulo de 88 MOTORIZADO (sin brazo)	486	507	525	547	589	441	4,6	0,61	49,4	1
 78	Tucán módulo de 78 MOTORIZADO (sin brazo)	455	475	492	512	551	414	4,3	0,54	43,8	1
 68	Tucán módulo de 68 MOTORIZADO (sin brazo)	446	465	482	501	539	405	4,2	0,47	38,2	1
 58	Tucán módulo de 58 MOTORIZADO (sin brazo)	433	451	468	486	523	393	4,1	0,4	32,6	1
 88	Tucán módulo de 88 FIJO (sin brazo)	308	332	353	377	425	256	5	0,61	33,8	1
 78	Tucán módulo de 78 FIJO (sin brazo)	287	310	329	351	395	240	4,7	0,54	30	1
 68	Tucán módulo de 68 FIJO (sin brazo)	279	301	321	343	387	232	4,6	0,47	26,2	1
 58	Tucán módulo de 58 FIJO (sin brazo)	266	287	306	327	369	221	4,5	0,4	22,3	1
 78 173 104	Tucán chaise longue de 104 (sentada de 78)	551	582	608	638	699	486	7	1,24	48,8	1
 68 173 94	Tucán chaise longue de 94 (sentada de 68)	537	568	595	625	685	473	7	1,13	42,5	1
 110 110	Tucán rincón 110 x 110	488	525	559	596	672	407	7,8	0,82	34	1
 104 103	Tucán terminal cabezal (1 asiento de 78)	419	447	471	499	554	360	6	0,73	23	1
 200 101	Tucán rincón - chaise longue	819	864	904	949	1040	722	9	1,37	51	1
 103 26 66	Tucán brazo almohada*	153	162	169	177	193	136	2	0,15	7	1
 103 21 66	Tucán brazo almohada* reducido - 5 cm.	153	162	169	177	193	136	2	0,15	7	1

Tucán Piel

Sofá motorizado



Tucán Piel



Tucán chaise longue de 290 cm. (2 asientos de 78 + chaise de 78).
Pata PM006. Piel Kálida blanco.

Tucán Piel

Sofá motorizado

Cabezal
tipo italiano



Tucán chaise longue de 290 cm. (2 asientos de 78 + chaise de 78). Pata PM006. Piel Kálida Nuez.

Pata de serie/
Standard

PM006
Metal



14 cm.



Grafito
Graphite

Botonera con USB incluida
Keypad with USB included
Clavier avec USB inclus



Tucán Piel

Sofá motorizado

Colores disponibles
Available colours
Couleurs disponibles

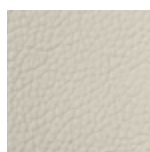

Blanco



Plata

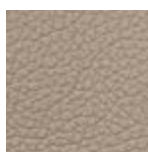

Nuez

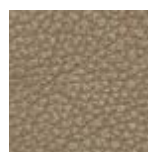

Taupe

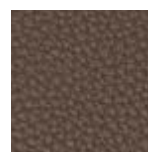

Testa di moro



Giallo



Cuoio

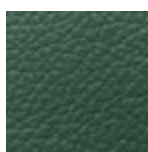

Verde

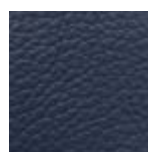

Blue

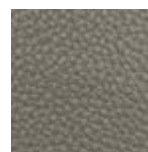

Antracita

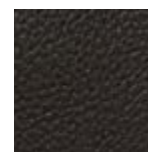





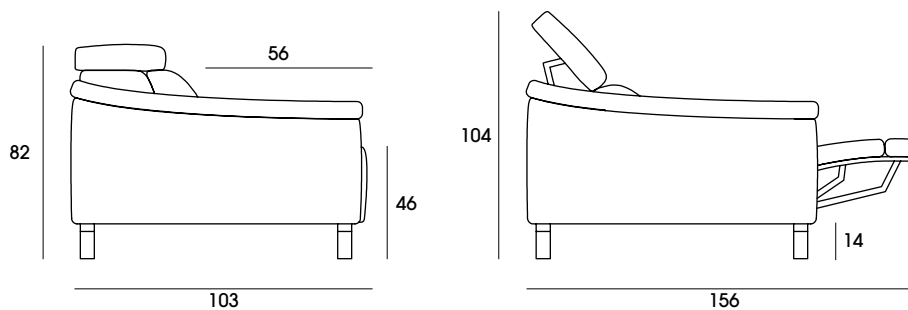

Negro

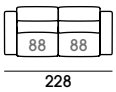
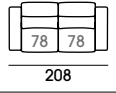
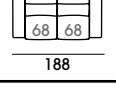
Tucán Piel

Medidas	Descripción	PIEL (KALIDA)
	Tucán chaiselongue 306 (2 motorizados de 88 con chaise de 104)	2618
	Tucán chaiselongue 286 (2 motorizados de 78 con chaise de 104)	2430
	Tucán chaiselongue 256 (2 motorizados de 68 con chaise de 94)	2283
	Tucán sofá 316 (3 motorizados de 78)	2730
	Tucán sofá 286 (3 motorizados de 78)	2508
	Tucán sofá 256 (3 motorizados de 68)	2325
	Tucán sofá 228 (2 motorizados de 88)	1954
	Tucán sofá 208 (2 motorizados de 78)	1798
	Tucán sofá 188 (2 motorizados de 68)	1676

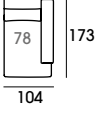
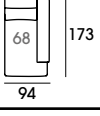
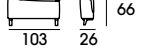

Medidas	Descripción	PIEL (KALIDA)
	Tucán sofá FIJO 228 (2 asientos FIJOS de 88)	1673
	Tucán sofá FIJO 208 (2 asientos FIJOS de 78)	1538
	Tucán sofá FIJO 188 (2 asientos FIJOS de 68)	1416
	Tucán módulo de 88 MOTORIZADO (sin brazo)	776
	Tucán módulo de 78 MOTORIZADO (sin brazo)	710
	Tucán módulo de 68 MOTORIZADO (sin brazo)	649
	Tucán módulo de 88 FIJO (sin brazo)	648
	Tucán módulo de 78 FIJO (sin brazo)	580
	Tucán módulo de 68 FIJO (sin brazo)	519
	Tucán chaiselongue de 104 (sentada de 78)	864
	Tucán chaiselongue de 94 (sentada de 68)	808
	Tucán brazo almohada	177

Papúa

Sofá motorizado



Papúa chaise longue de 314 cm. (2 asientos de 88 + chaise de 78).
Pata de madera color roble.



Papúa sofá de 294 cm. (3 asientos de 78).
Tela Laggo 3152 (interior) + Point Taupe (exterior)

Estructura de madera de pino y tablero.
Suspensión de muelles metálicos.
Mecanismo de apertura motorizada.
Asiento con de goma de 40 kg./m³.
Cabezal multiposición.
Almohadas desenfundables.
Asiento chaise longue no desenfundable.
Botonera con puerto USB, de serie.
Patatas de madera de haya de serie.
Patatas opcionales metálicas color grafito.

Structure in solid pine wood and fiber board.
Metallic spring suspension.
Motorized opening mechanism.
40 kg./m³ foam seat.
Multi-position headrest.
Removable covers.
Chaiselonge seat cover not removable.
Button panel with USB charging port.
Standart beech legs.
Metallic graphite coloured legs as option

Structure en bois de pin et DMF.
Suspension à ressort métallique.
Mécanisme d'ouverture motorisé.
Siège en caoutchouc de 40 kg./m³.
Tête multi-positions.
Oreillers amovibles.
Siège de chaise longue non amovible.
Panneau de boutons avec port de chargement USB.
Pieds en hêtre massif. Pieds en option de couleur graphite métallique.

Papúa

Sofá motorizado



Papúa

Papúa chaise longue de 294 cm. (2 asientos de 78 + chaise de 78).
Pata metálica color grafito. Tela Ermes color Hamster.

Botonera con USB incluida
Keypad with USB included
Clavier avec USB inclus



Incluye un cojín de 50 x 50 cm. por cada brazo.
Includes one 50 x 50 cm. cushion for each arm.
Comprend un coussin 50 x 50 cm. pour bras.



Papúa

Sofá motorizado

PM006
Metal



Acabado de patas*
Leg finish / Finition des jambes



Grafito
Graphite

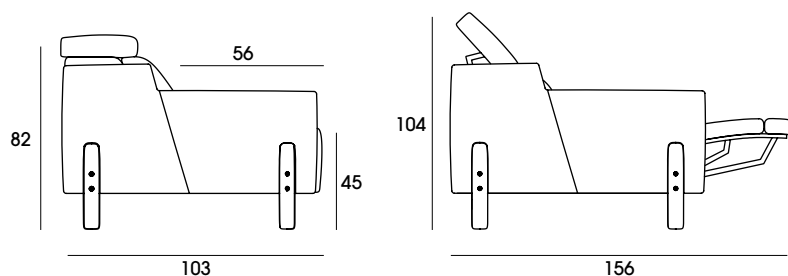

Medidas	Descripción	zero	SA	SB	SC	SD	TC				
	Papúa chaise longue 314 (2 motorizados de 88 con chaise de 108)	1639	1722	1795	1878	2044	1462	18	2,71	154,6	3
	Papúa chaise longue 294 (2 motorizados de 78 con chaise de 108)	1582	1663	1733	1814	1975	1411	17,5	2,57	143,4	3
	Papúa chaise longue 264 (2 motorizados de 68 con chaise de 98)	1552	1630	1699	1778	1935	1385	17	2,31	125,9	3
	Papúa chaise longue 244 (2 motorizados de 58 con chaise de 98)	1524	1601	1669	1747	1902	1359	16,5	2,17	114,7	3
	Papúa sofá 324 (3 motorizados de 88)	1751	1835	1908	1991	2153	1582	17	2,27	162,2	3
	Papúa sofá 294 (3 motorizados de 78)	1669	1747	1815	1893	2049	1503	16,5	2,06	145,4	3
	Papúa sofá 264 (3 motorizados de 68)	1642	1719	1786	1862	2015	1479	16	1,85	128,6	3
	Papúa sofá 234 (3 motorizados de 58)	1599	1674	1739	1813	1963	1441	15,5	1,64	111,8	3
	Papúa sofá 236 (2 motorizados de 88)	1265	1328	1383	1444	1564	1141	13,5	1,65	112,8	2
	Papúa sofá 216 (2 motorizados de 78)	1211	1270	1321	1380	1496	1087	13	1,51	101,6	2
	Papúa sofá 196 (2 motorizados de 68)	1194	1251	1301	1359	1474	1072	12,5	1,37	90,4	2
	Papúa sofá 176 (2 motorizados de 58)	1166	1222	1272	1328	1441	1046	12	1,23	79,2	2
	Papúa cojín 50 x 50 (relleno PLUS efecto plumón)	48	52	55	58	61	42	0,8	0,03	1	1



PW021

*Consultar para acabados especiales
Ask for special finishes
Consulter pour les finitions spéciales

Acabado de pata madera
Leg finish / Finition des jambes

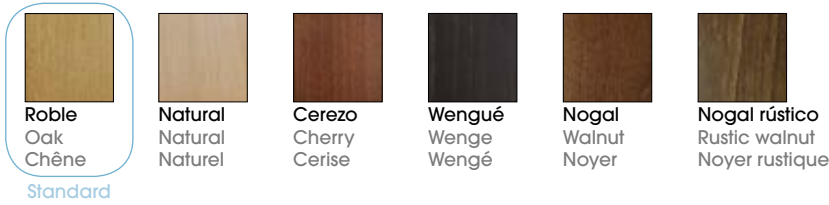

Medidas	Descripción	zero	SA	SB	SC	SD	TC				
	Papúa módulo de 88 MOTORIZADO (sin brazo)	486	507	525	547	589	441	4,6	0,61	49,4	1
	Papúa módulo de 78 MOTORIZADO (sin brazo)	455	475	492	512	551	414	4,3	0,55	43,8	1
	Papúa módulo de 68 MOTORIZADO (sin brazo)	446	465	482	501	539	405	4,2	0,47	38,2	1
	Papúa módulo de 58 MOTORIZADO (sin brazo)	433	451	468	486	523	393	4,1	0,4	32,6	1
	Papúa módulo de 88 FIJO (sin brazo)	308	332	353	377	425	256	5	0,61	33,8	1
	Papúa módulo de 78 FIJO (sin brazo)	287	310	329	351	395	240	4,7	0,55	30	1
	Papúa módulo de 68 FIJO (sin brazo)	279	301	321	343	387	232	4,6	0,47	26,2	1
	Papúa módulo de 58 FIJO (sin brazo)	266	287	306	327	369	221	4,5	0,4	22,3	1
	Papúa chaise longue de 108 (sentada de 78)	551	582	608	638	699	486	7,8	1,24	48,8	1
	Papúa chaise longue de 98 (sentada de 68)	537	568	595	625	685	473	7,8	1,15	42,5	1
	Papúa rincón 110 x 110	488	525	559	596	672	407	7,5	0,82	34	1
	Papúa terminal cabezal (sentada de 78)	419	447	471	499	554	360	6	0,73	23	1
	Papúa rincón - chaise longue	819	864	904	949	1040	722	9	1,37	51	1
	Papúa brazo recto (incluye 1 cojín decorativo)	153	162	169	177	193	136	2,8	0,15	7	1
	Papúa brazo recto reducido (- 10 cm.) (incluye 1 cojín decorativo)	153	162	169	177	193	136	2,6	0,13	6	1

Íbero

Sofá motorizado

Íbero



Sofá rinconera Íbero de 315 cm. x 315 cm. (motorizados de 90)
Piel Kálida Plata.

Estructura de madera de pino y tablero.
Suspensión de muelles metálicos.
Mecanismo de apertura motorizada.
Asiento con de goma de 35 kg./m³.
Cabezales motorizados (excepto en módulos fijos, chaise y rincón, que serán manuales).
Botonera exterior con puerto USB, de serie.
Botonera interior opcional (sin puerto USB)
Brazo almohada de serie.
Brazo recto opcional con cojín decorativo. (Con este brazo el sofá no lleva pata)

Botonera con USB incluida
Keypad with USB included
Clavier avec USB inclus



Structure in solid pine wood and fiber board.
Metallic spring suspension.
Motorized opening mechanism.
35 kg./m³ foam seat.
Motorized headrest (except in fixed modules, which will be with manual system).
Button panel with USB charging port.
Standard arm pillow.
Optional straight arm with decorative cushion.
(With this arm the sofa doesn't have a legs).

Structure en bois de pin et DMF.
Suspension à ressort métallique.
Mécanisme d'ouverture motorisé.
Siège en caoutchouc de 35 kg./m³.
Têtes motorisées (sauf dans les modules fixes, chaise longue et coin, qui seront manuels).
Clavier externe avec port USB, en standard.
Clavier intérieur en option (sans port USB)
Bras d'oreiller standard.
Bras étroit en option avec coussin décoratif. (Avec ce bras le canapé n'a pas de pied).



Íbero

Sofá motorizado



Sofá Íbero de 274 cm. con brazo almohada (2 motorizados de 110). Piel Kálida color antracita.

Íbero



Cabezal motorizado

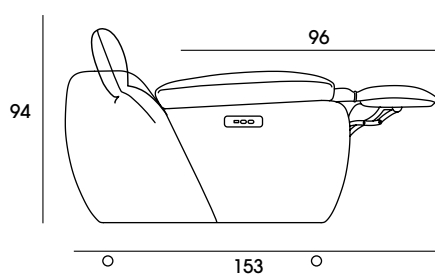
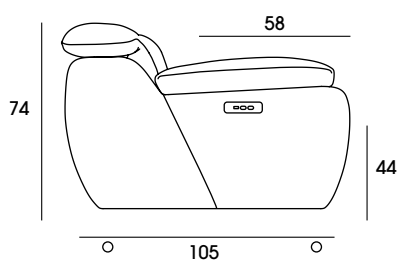

Pata de serie/
Standard

PM009
Metal



Negro
Black / Noir



Íbero

Sofá motorizado

Medidas	Descripción	zero	SA	SB	SC	SD	Kálicia	Dálmata	TC				
	Íbero chaise longue 354 (2 motorizados de 100 + chaise de 127)	2397	2490	2546	2603	2659	3411	4104	2264	16,4	4,09	191	3
	Íbero chaise longue 324 (2 motorizados de 90 + chaise de 117)	2299	2390	2445	2500	2555	3054	3836	2169	16	3,02	176	3
	Íbero chaise longue 304 (2 motorizados de 80 + chaise de 117)	2253	2339	2392	2444	2496	2998	3757	2130	15,2	2,87	164	3
	Íbero sofá de 354 (3 motorizados de 100)	2449	2537	2590	2643	2696	3218	3998	2325	15,4	2,75	204	3
	Íbero sofá de 324 (3 motorizados de 90)	2393	2477	2527	2578	2629	3123	3869	2274	14,7	2,51	188	3
	Íbero sofá de 294 (3 motorizados de 80)	2329	2408	2456	2505	2553	3040	3751	2215	14	2,28	170	3
	Íbero sofá de 274 (2 motorizados de 110)	1747	1811	1851	1890	1929	2315	2904	1654	11,4	2,12	157	2
	Íbero sofá de 254 (2 motorizados de 100)	1727	1790	1827	1865	1903	2269	2825	1638	11	1,97	146	2
	Íbero sofá de 234 (2 motorizados de 90)	1683	1743	1780	1817	1854	2198	2731	1596	10,7	1,81	135	2
	Íbero sofá de 214 (2 motorizados de 80)	1641	1700	1736	1772	1807	2142	2652	1557	10,4	1,66	123	2
	Íbero módulo 110 MOTORIZADO (sin brazo)	734	761	778	794	811	972	1212	695	4,8	0,85	64	1
	Íbero módulo 100 MOTORIZADO (sin brazo)	723	748	763	778	793	949	1173	687	4,4	0,77	58	1
	Íbero módulo 90 MOTORIZADO (sin brazo)	711	734	748	761	775	926	1138	679	4	0,7	53	1
	Íbero módulo 80 MOTORIZADO (sin brazo)	688	709	721	734	746	898	1099	659	3,6	0,62	47	1

*Las medidas son con el brazo de serie que será el ALMOHADA de 27cm., si se quiere el brazo recto de 16 cm. hay que indicarlo en el pedido.

Medidas	Descripción	zero	SA	SB	SC	SD	Kálida	Dálmata	TC				
	Íbero módulo 110 FIJO (sin brazo)	494	521	537	554	570	733	973	455	4,8	0,85	51	1
	Íbero módulo 100 FIJO (sin brazo)	482	507	522	538	553	710	934	447	4,4	0,77	45	1
	Íbero módulo 90 FIJO (sin brazo)	471	494	507	521	535	687	901	438	4	0,7	40	1
	Íbero módulo 80 FIJO (sin brazo)	448	468	481	493	506	664	867	419	3,6	0,62	34	1
	Íbero chaise longue de 127 (cabezal manual y sentada de 100)	828	868	892	916	940	1194	1532	772	7	1,55	60,5	1
	Íbero chaise longue de 117 (cabezal manual y sentada de 90)	745	781	803	825	847	1030	1333	693	6,4	1,42	56	1
	Íbero rincón 108 x 108 (cabezales manuales)	723	756	775	795	814	1006	1300	677	5,7	0,9	40	1
	Íbero terminal (cabezal manual)	615	643	659	676	692	865	1116	575	5,1	0,9	35	1
	Íbero brazo almohada de 27 cm.	133	142	147	153	158	174	228	120	1,6	0,19	14,5	1
	Íbero brazo recto de 16 cm. (Incluye 1 cojín decorativo por brazo)	133	142	147	153	158	174	228	120	1,6	0,11	9	1
	Íbero pouf rectangular 80 x 80	326	358	374	390	424	599	801	308	3	0,24	30	1
	Íbero pouf trapecio	326	358	374	390	424	664	867	308	3	0,24	30	1
	Cojín Íbero 50 x 50 (Relleno PLUS efecto plumón)	48	52	55	58	61	77	98	42	0,7	0,03	1	1

* Para el brazo recto de 16 cm. la tarifa es la misma. (Aunque la medida de las composiciones sean de -11 cm. por brazo.)

Mustang

Sofá motorizado



Mustang sofá de 316 cm. (3 asientos motorizados de 88 cm.)



Mustang rinconera + terminal + 2 motorizados con brazo recto.

Estructura de madera de pino y tablero.
Suspensión de muelles metálicos.
Mecanismo de apertura motorizada.
Asiento con goma de 30 kg./m³.
Respaldo con goma suave 25 kg./m³.
Cabezal multiposición.
Almohadas desenfundables.
Botonera con puerto USB, de serie.
Patas metálicas color cromo de serie.
Patas de madera opcional, sin incremento.

Structure in solid pine wood and board.
Metallic spring suspension.
Motorized opening mechanism.
Seat filled with 30 kg./m³ rubber.
Backrest with soft rubber 25 kg./m³.
Head with multiple positions.
Removable pillows.
Keypad with USB port, standard.
Metallic cromo coloured legs as standart.
Optional wooden legs, without increment.

Structure en bois de pin et DMF.
Suspension à ressort en métal zig-zag.
Mécanisme d'ouverture motorisé.
Siège rempli de caoutchouc 30 kg./m³.
Dossier en caoutchouc souple 25 kg./m³.
Tête avec plusieurs positions.
Oreillers amovibles.
Clavier avec port USB, standard.
Pieds standard en métal couleur cromo.
Pieds en bois en option, sans incrément.

Mustang

Sofá motorizado



Mustang rinconera + terminal + 2 motorizados con brazo recto.

Mustang

Incluye un cojín de 35 x 50 por cada brazo
Includes a 35 x 50 cushion for each arm
Comprend un coussin 35 x 50 pour chaque bras



La opción "brazo almohada", no incluye cojines extras.
The option "with arm pillow" does not include extra cushions.
L'option "avec coussin de bras" ne comprend pas de coussins

Botonera con USB incluida
Keypad with USB included
Clavier avec USB inclus



Acabado de pata madera
Leg finish / Finition des jambes



Natural
Natural
Naturel



Cerezo
Cherry
Cerise



Roble
Oak
Chêne



Wengué
Wenge
Wengé



Nogal
Walnut
Noyer



Nogal rústico
Rustic walnut
Noyer rustique

Pata de serie/
Standard



PM010
Metal



Cromo

*Consultar para acabados especiales / Ask for special finishes / Consulter pour les finitions spéciales





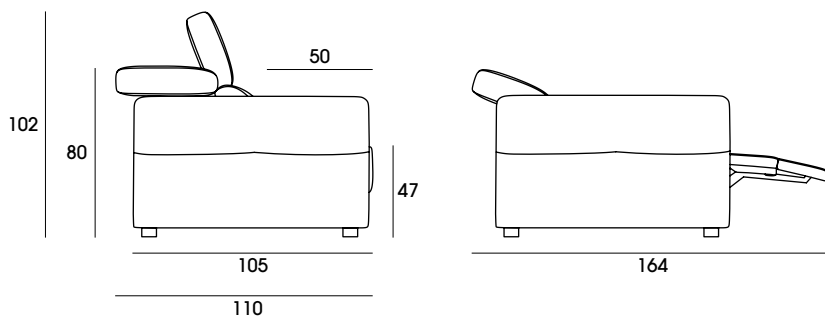





Mustang

Sofá motorizado

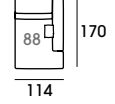
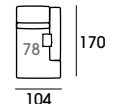
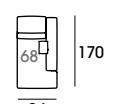
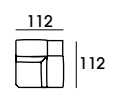
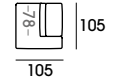
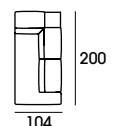
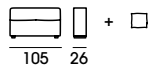
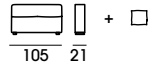
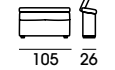

Medidas	Descripción	zero	SA	SB	SC	SD	TC				
 316	Mustang chaise longue 316 (2 motorizados de 88 con chaise de 88)	1511	1607	1692	1791	1982	1287	21	3,33	159	3
 286	Mustang chaise longue 286 (2 motorizados de 78 con chaise de 78)	1432	1522	1600	1690	1870	1223	21	3,01	143	3
 256	Mustang chaise longue 256 (2 motorizados de 68 con chaise de 68)	1413	1502	1579	1669	1846	1207	19	2,7	127	3
 314	Mustang rincón + terminal 314 (2 motorizados de 88 + rincón + terminal)	1803	1915	2010	2121	2340	1548	23	3,66	162	4
 294	Mustang rincón + terminal 294 (2 motorizados de 78 + rincón + terminal)	1745	1853	1946	2054	2268	1497	22	3,48	152	4
 274	Mustang rincón + terminal 274 (2 motorizados de 68 + rincón + terminal)	1736	1843	1937	2046	2260	1486	21	3,3	142	4
 306	Mustang rincón - chaise longue 306 (2 motorizados 88 + rincón - chaise longue)	1627	1724	1808	1903	2097	1405	21	3,43	157	3
 286	Mustang rincón - chaise longue 286 (2 motorizados 78 + rincón - chaise longue)	1568	1661	1744	1837	2060	1353	20	3,26	147	3
 266	Mustang rincón - chaise longue 266 (2 motorizados 68 + rincón - chaise longue)	1559	1653	1734	1829	2016	1341	19	3,08	137	3
 88	Mustang módulo de 88 MOTORIZADO (sin brazo)	447	467	485	506	546	400	4,5	0,78	45,1	1
 78	Mustang módulo de 78 MOTORIZADO (sin brazo)	418	437	453	472	510	374	4,2	0,69	40	1
 68	Mustang módulo de 68 MOTORIZADO (sin brazo)	410	428	443	461	497	368	4	0,6	34,8	1
 58	Mustang módulo de 58 MOTORIZADO (sin brazo)	402	419	433	450	484	363	3,8	0,51	29,7	1

Mustang

Medidas	Descripción	zero	SA	SB	SC	SD	TC				
	Mustang módulo 88 FIJO (sin brazo)	284	306	325	347	391	234	4,8	0,78	30,1	1
	Mustang módulo 78 FIJO (sin brazo)	266	286	305	325	367	218	4,6	0,69	25	1
	Mustang módulo 68 FIJO (sin brazo)	258	278	295	315	355	213	4,4	0,6	19,8	1
	Mustang módulo 58 FIJO (sin brazo)	251	270	287	305	343	208	4,2	0,51	14,7	1
	Mustang chaise longue de 114 (sentada de 88)	506	549	586	629	714	406	9	1,55	54	1
	Mustang chaise longue de 104 (sentada de 78)	492	533	569	610	693	397	8,7	1,41	48	1
	Mustang chaise longue de 94 (sentada de 68)	482	522	557	597	676	390	8,4	1,28	42	1
	Mustang rincón 112 x 112	442	474	503	536	601	366	10	1	34	1
	Mustang terminal cabezal (1 asiento de 78)	363	389	412	438	489	303	5,6	0,88	23	1
	Mustang rincón - chaise longue	628	673	712	757	846	524	9,5	1,66	52	1
	Mustang brazo recto de 26 (incluye 1 cojín decorativo)	111	124	136	150	176	81	3	0,18	15,3	1
	Mustang brazo recto de 21 (incluye 1 cojín decorativo)	111	124	136	150	176	81	3	0,14	13	1
	Mustang brazo almohada de 26 (con arcón)	124	135	144	154	175	100	2,5	0,18	16	1
	Mustang brazo almohada de 21 (sin arcón)	124	135	144	154	175	100	2,5	0,14	13,5	1
	Mustang cojín 35 x 50	21	25	27	29	35	15	0,6	0,02	0,6	1
	Incremento chaise longue arcón	64									
	Brazos de medida especial (por sofá)	37									

Habana

Sofá motorizado



Habana

Cabezal motorizado



Sofá Habana de 196 cm. (2 asientos motorizados de 86 cm.) Piel Kálida Taupe.

Habana

Sofá motorizado



Sofá Habana de 196 (2 asientos motorizados de 86 cm.) Piel Kálida Taupe.

Habana



Pata de serie/
Standard

PM014
Metal



10 cm.



Moka

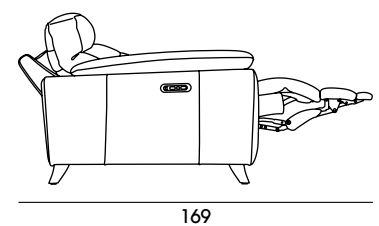
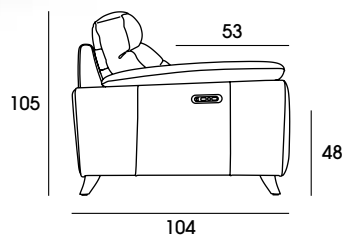

Habana

Sofá motorizado







Estructura de madera de pino y tablero.
Suspensión de muelles metálicos.
Mecanismo de apertura motorizada.
Asiento acolchado con de goma de 30 kg./m³.
Respaldo acolchado de fibra hueca siliconada.
Apoyabrazos de goma de 28 kg./m³.
Cabezales motorizados (excepto en módulos fijos, que serán fijos)
Botonera exterior con puerto USB, de serie.

Structure in solid pine wood and fiber board.
Metallic spring suspension.
Motorized opening mechanism.
Padded seat with 30 kg./m³ foam.
Padded silicone hollow fiber backrest.
28 kg./m³ foam armrests.
Motorized heads (except in fixed modules, which will be fixed).
Button panel with USB charging port.

Structure en bois de pin et DMF.
Suspension à ressort métallique.
Mécanisme d'ouverture motorisé.
Assise rembourrée en caoutchouc 30 kg./m³.
Dossier rembourré en fibres creuses de silicone.
Accoudoirs en caoutchouc 28 kg/m³.
Têtes motorisées (sauf dans les modules fixes, qui seront fixes)
Clavier externe avec port USB, en standard.

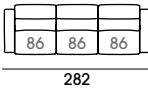
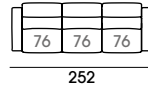
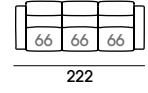
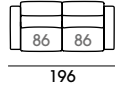
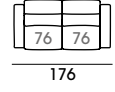
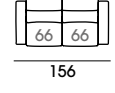
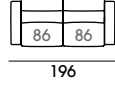
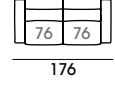
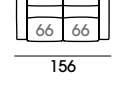

Sillón Habana motorizado. Piel Kálida Taupe.

Medidas	Descripción	zero	SA	SB	SC	SD	 Kálida	TC		 M³	 Kg.	 Uds
 100	Habana sillón de 100 (1 motorizado de 76)	762	795	816	836	857	1006	724	6	1,1	67,7	1
 100	Habana sillón FIJO de 100 (1 sentada de 76)	529	563	583	604	624	783	491	6	1,1	59,7	1
 282	Habana sofá de 282 (3 motorizados de 86)	2120	2205	2256	2308	2359	2686	2025	15	3,07	181	3
 252	Habana sofá de 252 (3 motorizados de 76)	2049	2127	2174	2221	2269	2598	1962	13,8	2,75	177	3
 222	Habana sofá de 222 (3 motorizados de 66)	1932	2003	2046	2089	2132	2441	1852	12,6	2,42	173	3
 196	Habana sofá de 196 (2 motorizados de 86)	1465	1524	1560	1596	1632	1872	1398	10,5	2,14	124	2
 176	Habana sofá de 176 (2 motorizados de 76)	1419	1475	1509	1543	1576	1813	1356	9,9	1,92	122,5	2
 156	Habana sofá de 156 (2 motorizados de 66)	1314	1365	1396	1427	1457	1684	1257	9	1,7	121	2
 196	Habana sofá FIJO de 196 (2 asientos de 86)	786	837	869	900	932	1202	727	9,2	2,14	112	1
 176	Habana sofá FIJO de 176 (2 asientos de 76)	759	808	838	868	898	1155	704	8,7	1,92	109	1
 156	Habana sofá FIJO de 156 (2 asientos de 66)	704	749	777	804	831	1081	653	8	1,7	106	1

Galo

Sofá motorizado

Galo



Galo composición chaise longue de 284
(2 motorizados de 78cm. con chaise de 78 cm.). Tela Gloria 372.

Cabezal multiposición
opcional con incremento

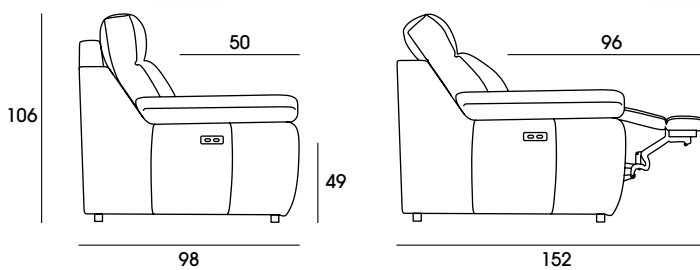

Botonera con USB incluida
Keypad with USB included
Clavier avec USB inclus





Galo sofá de 284 (3 motorizados de 78cm.). Tela Gloria 372

Estructura de madera de pino y tablero.
Suspensión de muelles metálicos.
Mecanismo de apertura motorizada.
Asiento con de goma de 32 kg./m³.
Reposa brazos de goma de 25 kg./m³ dura.
Respaldo y riñonera de fibra hueca siliconada.
Cabecera articulada en goma opcional con incremento (No recomendamos mezclar en un mismo sofá las dos tipos de cabeceras).
Almohadas desenfundables.
Chaise longue con arcón de serie.
Botonera con puerto USB, de serie.
Pata de madera color wengué de serie.

Arcón de serie.
Storage box as standard.
Boîte de rangement de série

Structure in solid pine wood and fiber board.
Metallic spring suspension.
Motorized opening mechanism.
32 kg./m³ foam seat.
Armrests in 25 kg./m³ hard rubber.
Backrest in silicone hollow fiber.
Optional rubber reclining headboard with increase (We do not recommend mixing the two types of headrest on the same sofa).
Removable pillows.
Chaise longue with storage box as standard.
Button panel with USB charging port.
Wenge colored wooden legs.



Structure en bois de pin et DMF.
Suspension à ressort métallique.
Mécanisme d'ouverture motorisé.
Siège en caoutchouc de 35 kg./m³.
Têtes motorisées (sauf dans les modules fixes, chaise longue et coin, qui seront manuels).
Panneau de boutons avec port de chargement USB.
Bras d'oreiller standard.
Bras étroit en option avec coussin décoratif.
(Avec ce bras le canapé n'a pas de pied).



Natural
Natural
Naturel



Roble
Oak
Chêne



Cerezo
Cherry
Cerise



Wengué
Wenge
Wengé

Standard



Nogal
Walnut
Noyer







Nogal rústico
Rustic walnut
Noyer rustique

Consultar para acabados especiales /
Ask for special finishes / Consulter pour les finitions spéciales.

Galo

Sofá motorizado

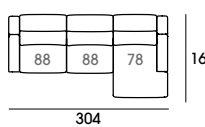
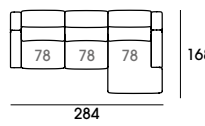
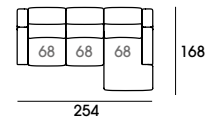
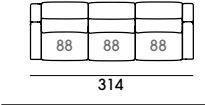
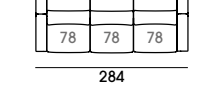
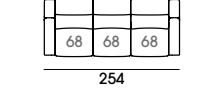
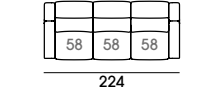
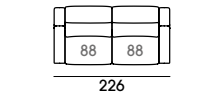
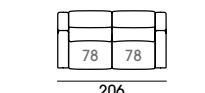
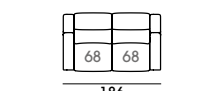
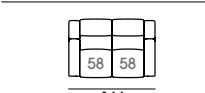
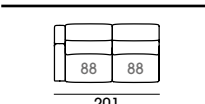
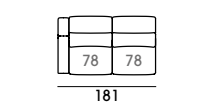
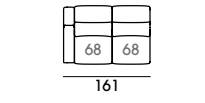
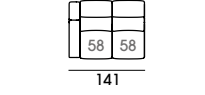
Medidas	Descripción	zero	SA	SB	SC	SD	TC	Incremento cabecera reclinable				
	Galo chaise longue 304 (2 motorizados de 88 + chaise de 103)	1504	1601	1660	1720	1779	1365	108	16,2	3,91	164	3
	Galo chaise longue 284 (2 motorizados de 78 + chaise de 103)	1475	1570	1628	1685	1743	1339	108	15,8	3,71	156	3
	Galo chaise longue 254 (2 motorizados de 68 + chaise de 93)	1460	1555	1613	1671	1728	1324	108	15,8	3,34	143	3
	Galo sofá 314 (3 motorizados de 88)	1546	1638	1695	1751	1808	1414	108	15,4	3,25	164	3
	Galo sofá 284 (3 motorizados de 78)	1503	1592	1646	1700	1754	1376	108	14,8	2,69	152	3
	Galo sofá 254 (3 motorizados de 68)	1478	1566	1618	1671	1724	1354	108	14,5	2,62	140	3
	Galo sofá 224 (3 motorizados de 58)	1470	1556	1608	1659	1751	1348	108	14,2	2,32	128	3
	Galo sofá 226 (2 motorizados de 88)	1116	1184	1226	1267	1309	1018	72	11,4	2,34	118	2
	Galo sofá 206 (2 motorizados de 78)	1087	1153	1193	1233	1273	992	72	11	2,14	110	2
	Galo sofá 186 (2 motorizados de 68)	1043	1108	1147	1187	1226	950	72	10,8	1,92	102	2
	Galo sofá 166 (2 motorizados de 58)	1037	1101	1140	1179	1217	946	72	10,6	1,72	94	2
	Galo módulo 201 (2 motorizados de 88 con 1 brazo)	1002	1061	1096	1132	1167	919	72	9,7	2,08	105	2
	Galo módulo 181 (2 motorizados de 78 con 1 brazo)	973	1029	1063	1097	1131	893	72	9,3	1,88	97	2
	Galo módulo 161 (2 motorizados de 68 con 1 brazo)	957	1012	1045	1078	1112	879	72	9,1	1,66	89	2
	Galo módulo 141 (2 motorizados de 58 con 1 brazo)	952	1005	1038	1070	1103	875	72	8,9	1,46	81	2

Medidas	Descripción	zero	SA	SB	SC	SD	TC	Incremento cabecera reclinable				
	Galo módulo 113 (1 motorizado de 88 con 1 brazo)	544	579	599	620	641	495	36	5,7	1,17	59	1
	Galo módulo 103 (1 motorizado de 78 con 1 brazo)	530	563	583	603	623	483	36	5,5	1,07	55	1
	Galo módulo 93 (1 motorizados de 68 con 1 brazo)	522	554	574	594	613	475	36	5,4	0,96	52	1
	Galo módulo 83 (1 motorizado de 58 con 1 brazo)	519	551	570	590	609	473	36	5,3	0,86	47	1
	Galo módulo MOTORIZADO de 88 (sin brazo)	458	483	497	512	526	424	36	4	0,91	46	1
	Galo módulo MOTORIZADO de 78 (sin brazo)	444	467	481	495	509	411	36	3,8	0,81	42	1
	Galo módulo MOTORIZADO de 68 (sin brazo)	436	458	472	485	499	404	36	3,7	0,7	38	1
	Galo módulo MOTORIZADO de 58 (sin brazo)	433	455	468	481	494	402	36	3,6	0,6	34	1
	Galo módulo FIJO de 88 (sin brazo)	325	349	364	379	393	291	36	4	0,91	42	1
	Galo módulo FIJO de 78 (sin brazo)	311	334	347	361	375	278	36	3,8	0,81	40	1
	Galo módulo FIJO de 68 (sin brazo)	304	327	340	354	367	273	36	3,7	0,7	36	1
	Galo módulo FIJO de 58 (sin brazo)	298	320	333	346	359	267	36	3,6	0,6	32	1
	Galo chaise longue ARCÓN de 103 (sentada de 78)	502	541	565	589	612	446	36	6,5	1,83	59	1
	Galo chaise longue ARCÓN de 93 (sentada de 68)	490	529	553	577	600	434	36	6,5	1,68	54	1
	Galo brazo almohada de 25	86	97	103	109	115	72	-	1,7	0,27	13	1

Magú

Sofá motorizado



Magú chaise longue de 290 cm. (3 motorizados de 78). Tela Loki beige



Magú chaise longue de 290 cm. (2 motorizados de 78 + chaise motorizada). Tela Loki beige.

Estructura de madera de pino y tablero.
Suspensión de muelles metálicos.
Mecanismo de apertura motorizada.
Chaise longue motorizado de serie,
con botonera dentro del brazo (mando
opcional al mismo precio).
Chaise longue fija opcional.
Brazos almohada con arcón, de serie.
Asiento con de goma de 40 kg/m³.
Cabezal articulado.
Almohadas desenfundables.
Patas metálicas color negro mate.

Structure in solid wood and fiber board.
Metallic spring suspension.
Motorized opening mechanism.
Motorized chaise longue as standard,
with buttons inside the arm (optional
remote control at the same price).
Optional fixed chaise longue.
Pillow arms with container, as standard.
40 kg./m³ foam seat.
Multi-position headrest.
Removable pillows.
Black metal legs.

Structure et plateau en bois de pin.
Suspension à ressort métallique.
Mécanisme d'ouverture motorisé.
Méristienne standard motorisée,
avec boutons à l'intérieur du bras
(télécommande en option au même prix).
Méristienne fixe en option.
Accoudoirs oreiller avec récipient, de série.
Assise avec caoutchouc 40 kg/m³.
Tête réglable.
Oreillers amovibles.
Pieds en métal noir mat.

Magú

Sofá motorizado

Cabezal
multiposición



Magú



Pata de serie/
Standard
PM009
Metal



PM009
Metal



Negro
Black / Noir



Cromo







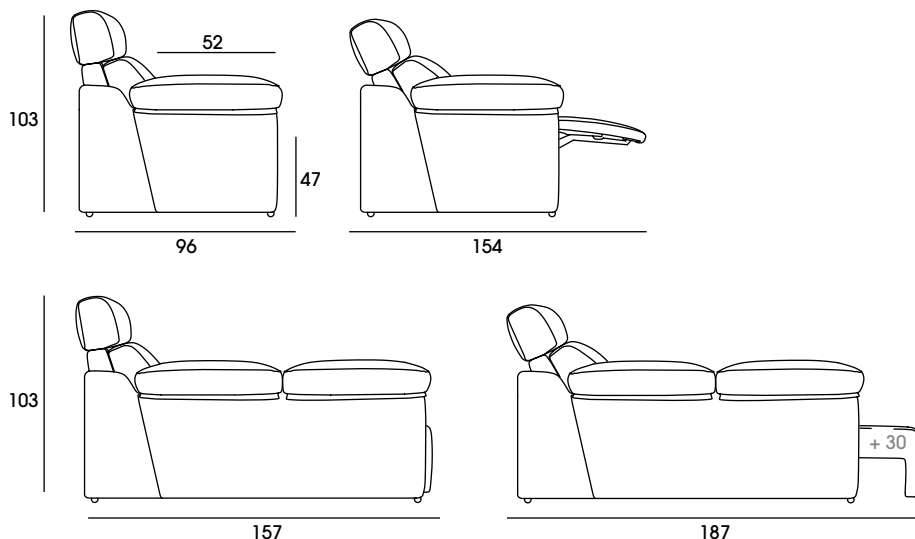









Magú

Sofá motorizado

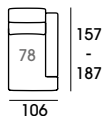
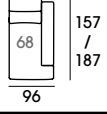
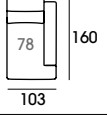
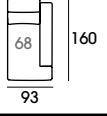
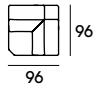
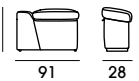

Medidas	Descripción	zero	SA	SB	SC	SD	TC				
 310	Magú chaise longue 310 (2 motorizados de 88 con chaise MOTORIZADA de 106)	1606	1680	1730	1795	1929	1497	18,8	3,75	139,2	3
 290	Magú chaise longue 290 (2 motorizados de 78 con chaise MOTORIZADA de 106)	1562	1634	1681	1746	1874	1458	18,5	3,56	129,2	3
 260	Magú chaise longue 260 (2 motorizados de 68 con chaise MOTORIZADA de 96)	1541	1613	1660	1723	1850	1439	18	3,2	113,9	3
 320	Magú sofá 320 (3 motorizados de 88)	1516	1585	1632	1694	1818	1415	16,5	3,16	150,4	3
 290	Magú sofá 290 (3 motorizados de 78)	1437	1501	1543	1599	1711	1346	15,8	2,86	135,4	3
 260	Magú sofá 260 (3 motorizados de 68)	1416	1478	1520	1574	1685	1327	15,2	2,57	120,4	3
 230	Magú sofá 230 (3 motorizados de 58)	1381	1443	1483	1537	1644	1293	14,7	2,27	105,4	3
 232	Magú sofá 232 (2 motorizados de 88)	1102	1151	1185	1229	1316	1030	12,5	2,29	106,4	2
 212	Magú sofá 212 (2 motorizados de 78)	1039	1086	1118	1162	1246	971	12,1	2,09	96,4	2
 192	Magú sofá 192 (2 motorizados de 68)	1025	1072	1104	1146	1229	958	11,7	1,9	86,4	2
 172	Magú sofá 172 (2 motorizados de 58)	981	1027	1057	1099	1179	914	11,3	1,7	76,4	2

Medidas	Descripción	zero	SA	SB	SC	SD	TC				
	Magú módulo de 88 MOTORIZADO (sin brazo)	439	456	461	483	511	416	4,6	0,87	44	1
	Magú módulo de 78 MOTORIZADO (sin brazo)	421	437	448	462	490	398	4,2	0,77	39	1
	Magú módulo de 68 MOTORIZADO (sin brazo)	411	425	435	449	477	388	4	0,67	34	1
	Magú módulo de 58 MOTORIZADO (sin brazo)	398	414	423	437	463	377	3,7	0,57	29	1
	Magú módulo de 88 FIJO (sin brazo)	293	312	325	340	374	267	4,7	0,87	31	1
	Magú módulo de 78 FIJO (sin brazo)	274	291	302	318	349	247	4,5	0,77	26	1
	Magú módulo de 68 FIJO (sin brazo)	265	283	293	309	339	240	4,1	0,67	21	1
	Magú módulo de 58 FIJO (sin brazo)	253	269	279	293	323	228	4	0,57	16	1
	Magú chaise longue 103 MOTORIZADO (sentada de 78)	661	695	718	749	809	612	8,60	1,74	42	1
	Magú chaise longue 93 MOTORIZADO (sentada de 68)	650	683	706	736	796	601	8,3	1,58	36,7	1
	Magú chaise longue 103 FIJO (sentada de 78)	537	572	596	627	689	486	9,2	1,74	27	1
	Magú chaise longue 93 FIJO (sentada de 68)	527	562	585	616	677	477	9	1,58	21,7	1
	Magú rincón 96 x 96	469	502	523	551	607	423	7,5	0,95	34	1
67 	Magú brazo almohada	104	112	118	125	140	91	2,6	0,15	9,2	1
67 	Magú brazo almohada reducido (-5)	104	112	118	125	140	91	2,6	0,12	7,8	1
Brazos de medida especial (por sofá)		37									

Magú

Nativa

Sofá motorizado

Estructura de madera de pino y tablero.
Suspensión de muelles metálicos.
Mecanismo de apertura motorizada.
Asiento con goma de 30 kg/m³.
Respaldo relleno de fibra de poliéster 100%.
Botonera con puerto USB de serie.
El brazo almohada NO incluye cojines decorativos.
Brazo recto y brazo almohada al mismo precio. *Con el fin de evitar errores es indispensable aclarar en cada pedido si el brazo va recto o almohada.
Patas metálicas de serie, color cromo.
Patas de madera opcionales.

Structure in solid pine and fiber board.
Metal spring suspension.
Motorized opening mechanism.
30 kg/m³ HR seat foam.
Back cushion with 100% polyester fiber.
Keypad with USB port, as standard.
The cushion arm doesn't include decorative cushions.
Straight arm and cushion arm at same price. *Please always specify choice of arm.
Metallic cromo coloured legs as standart.
Optional wooden legs, without increment.

Structure en bois de pin et DMF.
Suspension à ressort en métal.
Mécanisme d'ouverture motorisé.
Mousse assise: HR 30kg/m³.
Dossier garni en fibre de polyester 100%.
Boutonnière avec port USB d'office.
Assise, dossier, coussins deco déhoussables.
L'accoudoir type coussin n'inclut pas les coussins deco d'office.
Même prix pour l'accoudoir droit et l'accoudoir coussin. *Merci de détailler le type d'accoudoir souhaité sur votre commande.
Pieds métalliques d'office.
Pieds en bois en option.



Nativa de 226 cm. con brazo recto.



Nativa composición chaise longue de 284 cm. con brazo almohada.



Nativa sofá de 284 cm. con brazo almohada (3 motorizados de 78 cm).

Sillón relax Nativa a juego

pag. 148



Nativa

Sofá motorizado

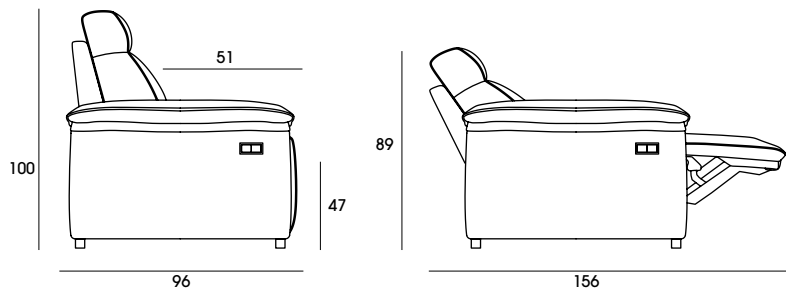

Botonera con USB incluida
Keypad with USB included
Clavier avec USB inclus



Nativa

Medidas	Descripción	zero	SA	SB	SC	SD	TC				
 88	Nativa sillón 88 (1 motorizado con brazos reducidos de 15)	568	610	637	674	748	490	7,5	0,84	32,4	1
 284	Nativa chaise longue 284 (2 motorizados de 78 con chaise de 103)	1355	1454	1519	1606	1780	1171	17,5	3,38	121	3
 254	Nativa chaise longue 254 (2 motorizados de 68 con chaise de 93)	1327	1424	1489	1575	1747	1144	17	2,94	107	3
 284	Nativa sofá 284 (3 motorizados de 78)	1358	1443	1499	1575	1725	1198	15	2,72	129	3
 254	Nativa sofá 254 (3 motorizados de 68)	1328	1413	1469	1545	1695	1168	15	2,44	114	3
 226	Nativa sofá 226 (2 motorizados de 88)	1092	1161	1207	1268	1390	963	12	2,17	101,2	2
 206	Nativa sofá 206 (2 motorizados de 78)	998	1062	1104	1160	1273	879	11,5	1,98	91,7	2
 186	Nativa sofá 186 (2 motorizados de 68)	980	1043	1084	1139	1250	863	11,3	1,78	82,2	2
 166	Nativa sofá 166 (2 motorizados de 58)	962	1023	1064	1118	1227	847	11	1,59	73	2
 88	Nativa módulo de 88 MOTORIZADO (sin brazo)	457	480	495	515	556	413	4,5	0,84	41,7	1
 78	Nativa módulo de 78 MOTORIZADO (sin brazo)	416	436	450	469	506	376	4,2	0,75	37	1
 68	Nativa módulo de 68 MOTORIZADO (sin brazo)	402	423	437	455	492	363	4	0,65	32,2	1
 58	Nativa módulo de 58 MOTORIZADO (sin brazo)	392	412	425	442	477	355	3,7	0,55	27,6	1



Pata de serie/
Standard

PM010
Metal



Cromo

*Consultar para acabados especiales
Ask for special finishes
Consulter pour les finitions spéciales

Acabado de pata madera
Leg finish / Finition des jambes



Natural
Natural
Naturel



Cerezo
Cherry
Cerise



Roble
Oak
Chêne



Wengué
Wenge
Wengé



Nogal
Walnut
Noyer



Nogal rústico
Rustic walnut
Noyer rustique

Medidas	Descripción	zero	SA	SB	SC	SD	TC				
 88	Nativa módulo de 88 FIJO (sin brazo)	283	309	327	350	396	234	5	0,84	28,7	1
 78	Nativa módulo de 78 FIJO (sin brazo)	256	281	297	319	364	209	4,7	0,75	24	1
 68	Nativa módulo de 68 FIJO (sin brazo)	248	272	288	309	351	204	4,5	0,65	19,2	1
 58	Nativa módulo de 58 FIJO (sin brazo)	232	255	270	290	330	190	4,2	0,55	14,6	1
 78 160 103	Nativa chaise longue 103 (sentada de 78) Brazo recto + 2 cojines decorativos	446	490	519	558	636	363	8	1,65	38,7	1
 68 160 93	Nativa chaise longue 93 (sentada de 68) Brazo recto + 2 cojines decorativos	443	486	515	553	630	361	8	1,49	33,7	1
 105 105	Nativa rincón 105 x 105	428	475	505	546	628	341	8	1,1	34	1
 95 25	Nativa brazo de 25 (misma tarifa para brazo almohada o recto)	89	100	108	117	137	69	2	0,24	8,9	1
 95 20	Nativa brazo reducido de 20 (misma tarifa para brazo almohada o recto)	89	100	108	117	137	69	2	0,19	7,2	1
 30 40	Nativa cojín 30 x 40	21	25	27	29	35	15	0,7	0,02	0,5	1
	Incremento chaise longue arcón	64									
	Brazos con medida especial (por sofá)	37									

Angie

Sofá motorizado



Angie sofá de 232 cm. (2 motorizados de 88 cm.)



Angie composición chaise longue de 290 cm. (2 motorizados de 78 + chaise de 78 cm.)

Angie

Sofá motorizado



Cabezal multiposición

Angie



Estructura de pino y tablero MDF.
Mecanismo relax eléctrico.
Suspensión de muelles metálicos.
Asiento de goma de 30 kg./m³.
Respaldo 100% de fibra de poliéster.
Brazo recto opcional (siempre indicándolo en el pedido)
Cabezal multiposición.
Pata de madera de pino macizo.

Pine structure and MDF board.
Electric relax mechanism.
Metal spring suspension.
30 kg./m³ foam seat.
Back cushion with 100% polyester fiber.
Optional straight arm (always indicating it in the order)
Multi-position headrest.
Solid pine wood leg.

Structure en pin et panneau MDF.
Mécanisme de relaxation électrique.
Suspension à ressort en métal.
Siège en caoutchouc 30 kg./m³.
Support en fibre 100% polyester.
Bras droit en option (en l'indiquant toujours dans la commande)
Tête multi-positions.
Pied en bois de pin massif.

Angie

Sofá motorizado

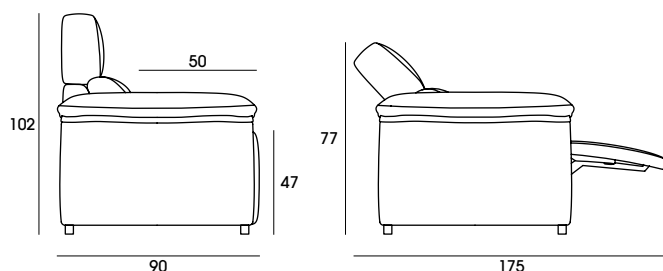

Acabado de pata madera
Leg finish / Finition des jambes



*Consultar para acabados especiales / Ask for special finishes / Consulter pour les finitions spéciales

Medidas	Descripción	zero	SA	SB	SC	SD	TC				
 90	Angie sillón de 90 (1 motorizado de 58)	524	576	601	632	696	468	6,5	0,82	32,4	1
 290	Angie chaise longue 290 (2 motorizados de 78 con chaise de 78)	1302	1430	1490	1568	1727	1158	16	3,31	121	3
 260	Angie chaise longue 260 (2 motorizados de 68 con chaise de 68)	1268	1394	1451	1529	1682	1128	15,5	2,97	107	3
 290	Angie sofá 290 (3 motorizados de 78)	1407	1506	1580	1649	1787	1286	14,2	2,63	129	3
 260	Angie sofá 260 (3 motorizados de 68)	1380	1490	1538	1610	1742	1262	13,4	2,36	114	3
 232	Angie sofá 232 (2 motorizados de 88)	1070	1160	1200	1255	1364	973	13	2,11	101	2
 212	Angie sofá 212 (2 motorizados de 78)	971	1059	1097	1149	1251	882	10,5	1,92	92	2
 192	Angie sofá 192 (2 motorizados de 68)	951	1036	1072	1122	1221	866	10	1,74	82,2	2
 172	Angie sofá 172 (2 motorizados de 58)	931	1013	1049	1097	1192	849	9,5	1,56	73	2

Medidas	Descripción	zero	SA	SB	SC	SD	TC				
	Angie módulo de 88 MOTORIZADO (sin brazo)	472	507	520	539	576	443	4	0,8	41,7	1
	Angie módulo de 78 MOTORIZADO (sin brazo)	427	460	474	491	525	400	4	0,71	37	1
	Angie módulo de 68 MOTORIZADO (sin brazo)	418	448	460	478	510	392	3,5	0,62	32,2	1
	Angie módulo de 58 MOTORIZADO (sin brazo)	405	434	446	461	492	381	3,5	0,53	27,6	1
	Angie módulo de 88 FIJO (sin brazo)	263	296	312	333	377	222	4,5	0,8	28,7	1
	Angie módulo de 78 FIJO (sin brazo)	244	274	290	310	352	203	4,5	0,71	24	1
	Angie módulo de 68 FIJO (sin brazo)	236	265	280	300	338	198	4	0,62	19,2	1
	Angie módulo de 58 FIJO (sin brazo)	229	256	270	289	325	193	4	0,53	14,6	1
	Angie chaise longue 106 (sentada de 78) Incluye 1 cojín decorativo.	405	446	474	510	584	319	7,5	1,73	38,7	1
	Angie chaise longue 96 (sentada de 68) Incluye 1 cojín decorativo.	386	427	453	490	561	303	7,5	1,57	33,7	1
	Angie rincón 96 x 96	365	412	435	468	531	302	7	0,94	34	1
	Angie brazo almohada 28	63	73	79	88	106	43	2	0,16	8,9	1
	Angie brazo almohada reducido 23 (-5)	63	73	79	88	106	43	2	0,13	7,2	1
	Angie cojín 50 x 50	21	25	27	29	35	15	0,7	0,2	0,7	1
	Incremento chaise longue arcón	64									
	Incremento botonera USB	17									
	Incremento brazo arcón	38									
	Brazos medida especial (por sofá)	37									

Diverso

Sofá motorizado



Diverso sofá de 260 cm. (3 motorizados de 77 cm.). Pata de madera natural.
Tela Cavalli 16.



Estructura de pino y tablero MDF.
Suspensión con muelle metálico.
Asiento de goma de 30 kg./m³.
Respaldo con fibra reciclada.
Asiento, respaldo y cubrebrazos desenfundables.
Botonera con puerto USB de serie.
Patatas de madera de haya maciza.

Solid pine and fiber board structure.
Metal spring suspension.
30 kg./m³ foam seat.
Back cushion with recycled fiber.
Loose cover on seat, backrest and armrest.
Keypad with serial USB port.
Solid beech wood legs.

Cadre en pin et panneau MDF.
Suspension avec ressort en métal.
Siège en caoutchouc 30 kg./m³.
Support en fibre recyclée.
Assise, dossier et accoudoir amovibles.
Clavier avec port USB série.
Pieds en bois de hêtre massif.





Diverso

Sofá motorizado

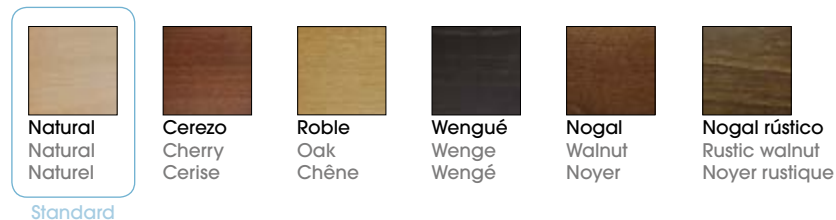



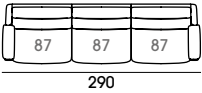
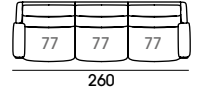
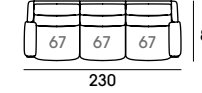
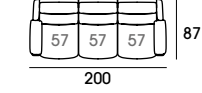
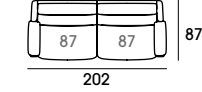
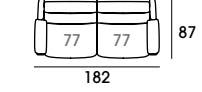
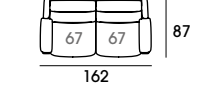
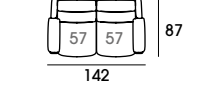
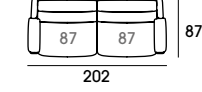
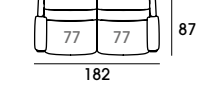
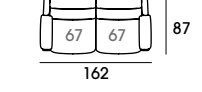



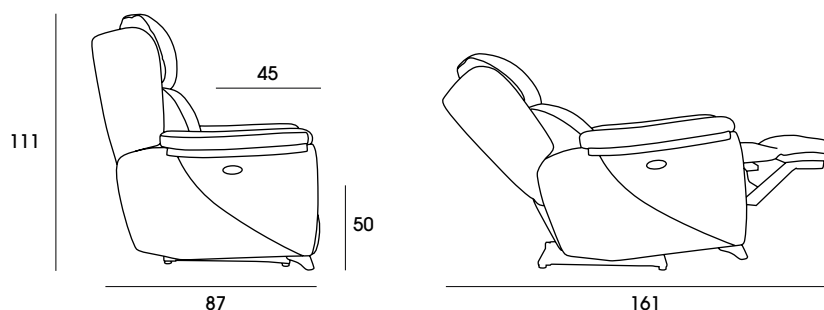





Acabado de pata madera
Leg finish / Finition des jambes



*Consultar para acabados especiales
Ask for special finishes
Consulter pour les finitions spéciales

Medidas	Descripción	zero	SA	SB	SC	SD	Dálmata	TC		MP	Kg.	Uds.
	Diverso sofá 290 (3 asientos MOTORIZADOS de 87)	1437	1552	1608	1661	1702	2781	1365	15,8	2,96	137	3
	Diverso sofá 260 (3 asientos MOTORIZADOS de 77)	1365	1477	1527	1580	1618	2681	1296	14,6	2,66	129	3
	Diverso sofá 230 (3 asientos MOTORIZADOS de 67)	1296	1405	1455	1502	1543	2538	1230	13,7	2,35	120	3
	Diverso sofá 200 (3 asientos MOTORIZADOS de 57)	1221	1318	1362	1409	1441	2397	1161	12,8	2,04	88,5	3
	Diverso sofá 202 (2 asientos MOTORIZADOS de 87)	1014	1100	1144	1186	1222	1994	956	11,6	2,04	96,7	2
	Diverso sofá 182 (2 asientos MOTORIZADOS de 77)	966	1050	1090	1132	1166	1932	910	10,8	1,84	91,6	2
	Diverso sofá 162 (2 asientos MOTORIZADOS de 67)	920	1002	1042	1080	1116	1832	866	10,2	1,64	85,8	2
	Diverso sofá 142 (2 asientos MOTORIZADOS de 57)	870	944	980	1018	1048	1738	820	9,6	1,43	82	2
	Diverso sofá 202 (2 asientos FIJOS de 87)	752	840	882	924	960	1738	694	11,6	2,14	69	2
	Diverso sofá 182 (2 asientos FIJOS de 77)	720	804	844	886	920	1688	662	10,8	1,88	64,9	2
	Diverso sofá 162 (2 asientos FIJOS de 67)	640	722	760	800	836	1584	586	10,2	1,7	59	1
	Diverso sofá 142 (2 asientos FIJOS de 57)	590	664	700	736	768	1516	540	9,6	1,49	55,5	1

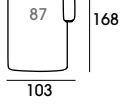
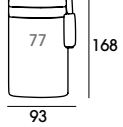

Medidas	Descripción	zero	SA	SB	SC	SD	 Dalmata	TC		 M ³	 Kg.	 Uds
	Diverso módulo de 87 MOTORIZADO (sin brazo)	423	452	464	475	480	787	409	4,2	0,88	40,4	1
	Diverso módulo de 77 MOTORIZADO (sin brazo)	399	427	437	448	452	756	386	3,8	0,78	37,8	1
	Diverso módulo de 67 MOTORIZADO (sin brazo)	376	403	413	422	427	706	364	3,4	0,68	34,9	1
	Diverso módulo de 57 MOTORIZADO (sin brazo)	351	374	382	391	393	659	341	3,1	0,58	33	1
	Diverso módulo de 87 FIJO (sin brazo)	292	322	333	344	349	659	278	4,2	0,88	26,5	1
	Diverso módulo de 77 FIJO (sin brazo)	276	304	314	325	329	634	262	3,8	0,78	25,2	1
	Diverso módulo de 67 FIJO (sin brazo)	260	287	296	306	311	582	248	3,4	0,68	24,5	1
	Diverso módulo de 57 FIJO (sin brazo)	235	258	266	274	277	548	225	3,1	0,58	19,7	1
	Diverso chaise longue 103 (sentada de 87)	488	535	563	591	621	1074	436	8	1,9	50,5	1
	Diverso chaise longue 93 (sentada de 77)	472	515	541	568	596	1018	423	7,5	1,71	42	1
	Diverso brazo almohada	84	98	108	118	131	210	69	1,6	0,1	8	1
	Cubre-brazo (x 2 u.)	34	37	40	43	46	-	30	0,6	0,02	0,5	1
	Cubre-cabeza	34	37	40	43	46	-	30	0,6	0,02	0,5	1

Stich

Sofá cama



Stich sofá cama de 186 cm. (Colchón de 140 cm.).
Tela Charlotte pistacho. Cojines decorativos en Selva aguamarina.



Estructura de pino y tablero MDF.
Mecanismo con recogida total de almohadas.
Mecanismo suspendido (apoyo sólo por las patas).
Asiento con goma 30 kg./m³.
Almohadas desenfundables.
Incluye 2 cojines de 45 x 45.

Solid pine and fiber board structure.
Sliding and folding mechanism.
Suspended mechanism (support by the legs only).
Foam seat 30 kg./m³.
Removable pillows.
Includes 2 45 x 45 cushions.

Structure en pin et panneau MDF.
Mécanisme avec collection complète d'oreillers.
Mécanisme suspendu (support juste par les jambes).
Siège en caoutchouc 30 kg./m³.
Oreillers amovibles.
Comprend 2 coussins 45 x 45.

Stich
Sofá cama



Stich sofá cama con chaise longue 265 cm. (Colchón de 140 cm) Tela Zafiro 4.

Stich

Stich

Sofá cama



Altura óptima para robot-aspirador.
Optimal height for robot vacuum cleaner.
Hauteur optimale pour robot aspirateur.



Colchón goma
Foam mattress
Matelas en caoutchouc



Pata de serie/
Standard



Acabado de pata madera
Leg finish / Finition des jambes



Natural
Natural
Naturel



Cerezo
Cherry
Cerise



Roble
Oak
Chêne



Wengué
Wenge
Wengé



Nogal
Walnut
Noyer



Nogal rústico
Rustic walnut
Noyer rustique

PM011
Metal



12,5 cm.



Negro
Black / Noir

*Consultar para acabados especiales / Ask for special finishes / Consulter pour les finitions spéciales

Incluye 2 cojines 45 x 45
2 pcs. 45x45 cushion included
2 pièces Coussin 45x45 inclus

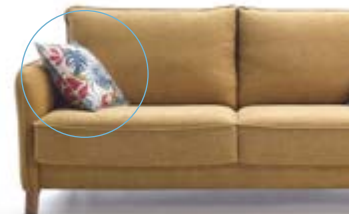
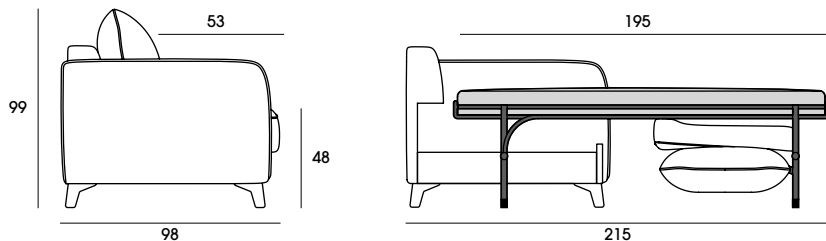

Medidas	Descripción	zero	SA	SB	SC	SD	TC				
	Stich sofá cama 206 Colchón / Mattress / Matelas 160 x 195	978	1048	1091	1134	1177	877	12	2	86	2
	Stich sofá cama 186 Colchón / Mattress / Matelas 140 x 195	915	982	1022	1063	1103	821	11,3	1,8	78,6	2
	Stich sofá cama 166 Colchón / Mattress / Matelas 120 x 195	875	937	974	1012	1049	787	10,5	1,61	71,2	2
	Stich sofá cama 146 Colchón / Mattress / Matelas 100 x 195	768	824	857	891	924	689	9,4	1,42	63,8	2
	Stich sofá cama 126 Colchón / Mattress / Matelas 80 x 195	743	795	826	857	889	669	8,4	1,22	52	2
	Stich composición chaise longue 295 Colchón / Mattress / Matelas 160 x 195	1410	1512	1573	1635	1696	1266	17,2	3,5	121,7	2
	Stich composición chaise longue 265 Colchón / Mattress / Matelas 140 x 195	1321	1416	1474	1531	1589	1186	16,1	3,13	108,6	2
	Stich cojín de 45 x 45	21	25	27	29	35	15	0,7	0,03	0,6	1

Stich

Wanda

Sofá cama



Wanda sofá cama 214 cm. (Colchón de 140 cm.) Tela Amaral 305.



Estructura de pino y tablero MDF.
Mecanismo con recogida total
de almohadas.
Mecanismo suspendido.
Asiento con goma 30 kg./m³.
Almohadas desenfundables.
Incluye 2 cojines de 45x55 cm.

Solid pine and fiber board structure.
Sliding and folding mechanism.
Suspended mechanism (support
by the legs only).
Foam seat 30 kg./m³.
Loose covers
Includes 2 45 x 55 cushions.

Structure en pin et panneau MDF.
Mécanisme avec collection
complète d'oreillers.
Mécanisme suspendu (support
juste par les jambes).
Siège en caoutchouc 30 kg./m³.
Oreillers amovibles.
Comprend 2 coussins 45x55 cm.

Wanda
Sofá cama



Wanda sofá cama con chaise longue 296 cm. (Colchón de 140 cm.). Tela Velvet Lin 73.

Wanda

Wanda

Sofá cama



Wanda

Altura óptima para robot-aspirador.
Optimal height for robot vacuum cleaner.
Hauteur optimale pour robot aspirateur.



Colchón goma
Foam mattress
Matelas en caoutchouc



Pata de serie/
Standard



12 cm.

*Consultar para acabados especiales
Ask for special finishes
Consulter pour les finitions spéciales

Acabado de pata madera
Leg finish / Finition des jambes



Natural
Natural
Naturel



Cerezo
Cherry
Cerise



Roble
Oak
Chêne



Wengué
Wenge
Wengé



Nogal
Walnut
Noyer



Nogal rústico
Rustic walnut
Noyer rustique



Negro
Black / Noir



PM011
Metal

12,5 cm.

Wanda

Sofá cama

Incluye 2 cojines 45x55
2 pcs. 45x55 cushion included
2 pièces Coussin 45x55 inclus

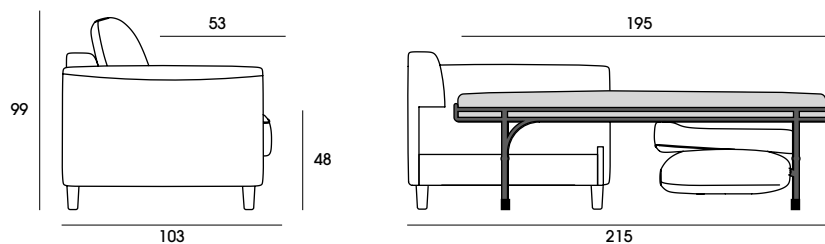

Medidas	Descripción	zero	SA	SB	SC	SD	TC				
	Wanda sofá cama 234 Colchón / Mattress / Matelas 160 x 195	1007	1086	1133	1181	1221	896	12,5	2,39	90	2
	Wanda sofá cama 214 Colchón / Mattress / Matelas 140 x 195	944	1018	1063	1108	1153	838	12	2,18	82,6	2
	Wanda sofá cama 194 Colchón / Mattress / Matelas 120 x 195	883	952	994	1036	1079	784	11	1,98	75,2	2
	Wanda sofá cama 174 Colchón / Mattress / Matelas 100 x 195	809	871	909	947	985	739	10	1,77	67,8	2
	Wanda sofá cama 154 Colchón / Mattress / Matelas 80 x 195	768	824	858	892	926	706	9	1,57	56	2
	Wanda chaise longue 326 Colchón / Mattress / Matelas 160 x 195	1440	1551	1618	1685	1752	1282	18	3,89	125,7	2
	Wanda chaise longue 296 Colchón / Mattress / Matelas 140 x 195	1351	1454	1517	1580	1643	1203	17	3,5	112,6	2
	Wanda cojín de 45 x 55	21	25	27	29	35	15	0,8	0,03	0,7	1
	Brazo reducido de -5 cm.	63 (por sofá)									

Wanda

Botton

Sofá cama



Botton sofá cama 180 cm. (Colchón de 140 cm.) Tela Aldebarán 45



Botton

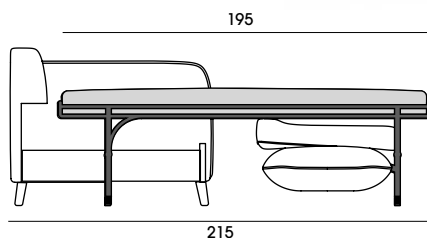
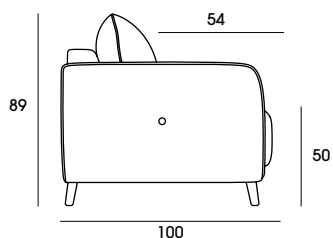

Estructura de pino y tablero MDF.
Mecanismo con recogida total de almohadas.
Asiento con goma 30 kg./m³.
Almohadas desenfundables.
Patas y botones de haya maciza.
Incluye 2 cojines de 50x30.

Solid pine and fiber board structure.
Sliding and folding mechanism.
Foam seat 30 kg./m³.
Loose covers.
Solid buttons and beech legs.
Includes 2 50x30 cushions.

Structure en pin et panneau MDF.
Mécanisme avec collection complète d'oreillers.
Siège en caoutchouc 30 kg./m³.
Oreillers amovibles.
Pieds et boutons en hêtre massif.
Comprend 2 coussins 50x30.



Colchón goma
Foam mattress
Matelas en caoutchouc



Botón a juego de patas
Leg matching button
Bouton correspondant à la jambe



Incluye 2 cojines 50x30
2 pcs. 50x30 cushion included
2 pièces Coussin 50x3 inclus

Medidas	Descripción	zero	SA	SB	SC	SD	TC				
	Botton sofá cama 200 Colchón / Mattress / Matelas 160 x 195	1005	1059	1092	1125	1158	944	9,3	1,87	86	2
	Botton sofá cama 180 Colchón / Mattress / Matelas 140 x 195	938	988	1019	1049	1080	881	8,9	1,69	78,6	2
	Botton sofá cama 160 Colchón / Mattress / Matelas 120 x 195	857	903	931	959	988	805	8	1,51	71,2	2
	Botton sofá cama 140 Colchón / Mattress / Matelas 100 x 195	805	847	873	898	924	757	7,3	1,33	63,8	2
	Botton sofá cama 120 Colchón / Mattress / Matelas 80 x 195	780	818	842	865	888	738	6,7	1,15	52	2
	Botton cojín de 50 x 30	21	25	27	29	35	15	0,7	0,02	0,6	1

Botton



Acabado de pata madera
Leg finish / Finition des jambes

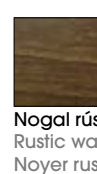
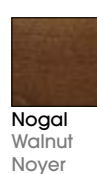
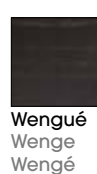
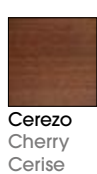
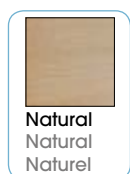

*Consultar para acabados especiales
Ask for special finishes
Consulter pour les finitions spéciales

City

Sillón relax



Relax City ap. motorizada. Tela Zeus 04

City

Estructura de pino y tablero MDF.
Suspensión mediante muelles metálicos.
Asiento con goma de 30 kg./m³.
Cabezal motorizado.
Riñonera, brazos y asiento desenfundables.
Botonera con puerto USB de serie.

Structure in solid pine and fiber board.
Suspension with metal spring.
Foam seat 30 kg./m³.
Motorized headrest.
Loose cover seat, back and arm pads.
Keypad with serial USB port.

Structure en bois de pin et panneau MDF.
Suspension par ressort métallique.
Assise avec caoutchouc 35 kg./m³.
Tête motorisée.
Oreillers amovibles.
Clavier avec port USB série.



Cabezal motorizado



Medidas	Descripción	zero	SA	SB	SC	SD	TC				
	City apertura motorizada (asiento de 57)	601	638	660	683	705	560	6,2	0,78	48	1
	City XL apertura motorizada (asiento extra ancho de 67)	639	677	699	722	745	597	6,4	0,88	52	1
EXTRAS	Cubre-brazo (2 u.) Arm cover (x 2) Couvre bras (x 2)	34	37	40	43	46	30	0,6	0,02	0,5	1
	Cubre-cabeza Head cover Couvre tête	34	37	40	43	46	30	0,7	0,02	0,5	1
	Kit batería Battery kit Kit batterie	172									

MECANISMO



Apertura motorizada
Motorized opening
Ouverture motorisée

OPCIONAL

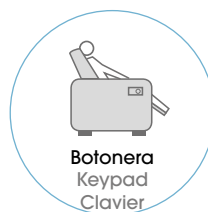

Botonera
Keypad
Clavier

Standard



Mando con cable
Wired controller
Contrôleur filaire

EXTRAS



Cubre-brazo
Arm cover
Couvre bras



Cubre-cabeza
Head cover
Couvre tête

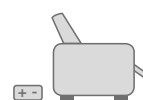

Kit batería
Battery kit
Kit batterie

Genial

Sillón relax

Estructura de pino y tablero MDF.
Suspensión mediante muelles metálicos.
Asiento con goma 35 kg./m³ + 32 kg./m³.
Almohadas desenfundables.
Respaldo desmontable de serie.
Sólo las opciones de Power lift tienen sistema "INCLINACIÓN PLUS" y doble piecero.
Botonera con puerto USB de serie.
Patatas inyectadas negras, de serie.
Patatas de madera opcional.

Structure in solid pine and fiber board.
Suspension with metal spring.
Foam Seat 35 kg./m³ + 32 kg./m³.
Loose covers.
Only the Power lift options (one and two motors) have the "PLUS RECLINER" system, and the double foot rest.
Keypad with serial USB port. Black injected legs.
Black PVC legs.
Optional wooden legs.

Structure en bois de pin et panneau MDF.
Suspension par ressort métallique.
Assise avec caoutchouc 35 kg./m³ + 32 kg./m³.
Oreillers amovibles.
Dossier amovible de série.
Seules les options de levage électrique (un et deux moteurs) ont un système d'INCLINAISON PLUS et un double repose-pieds.
Clavier avec port USB série.
Jambes injectées noires.
Pieds en bois en option.



Relax Genial power lift 1 motor. Tela Diosa 60



Pata
inyectada



Negro
Black / Noir

Standard

Medidas	Descripción	zero	SA	SB	SC	SD	TC				
	Genial apertura manual (empuje)	412	458	482	506	530	360	6,5	0,75	40	1
	Genial apertura motorizada (botonera con USB)	554	611	641	671	700	513	6,5	0,75	46,6	1
	Genial power lift 1 motor con doble piecero INCLINACIÓN PLUS (botonera con USB)	632	697	726	755	784	594	6,5	0,75	60,6	1
	Genial power lift 2 motores con doble piecero INCLINACIÓN PLUS (mando con cable)	726	779	808	837	867	686	6,5	0,75	63,2	1
EXTRAS	Cubre-brazo (2 u.) Arm cover (x 2) Couvre bras (x 2)	34	37	40	43	46	30	1	0,02	0,5	1
	Cubre-cabeza Head cover Couvre tête	34	37	40	43	46	30	0,7	0,02	0,5	1
	Kit batería Battery kit Kit batterie	172									
	Calefacción* Heating Le chauffage	84									
	Kit de ruedas** Wheel kit Kit de roue	84									

* La calefacción no es compatible con el kit batería / The heating is not compatible with the battery kit / Le chauffage n'est pas compatible avec le kit batterie.

** Solo posible en versión powerlift 1 y 2 motores / Only possible in 1 and 2 motor powerlift version / Uniquement possible en version powerlift 1 et 2 moteurs.

MECANISMO

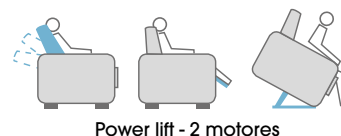
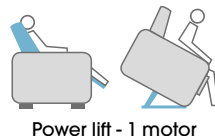

"INCLINACIÓN PLUS"

Con Inclinación extra para un máximo confort y descanso
With extra incline for maximum comfort and rest
Avec inclinaison supplémentaire pour un maximum de confort et de repos

OPCIONAL



Genio

Sillón relax

Estructura de pino y tablero MDF.
Suspensión mediante muelles metálicos.
Asiento con goma 35 kg./m³ + 32 kg./m³.
Almohadas desenfundables.
Respaldo desmontable de serie.
Sólo las opciones de Power lift tienen sistema "INCLINACIÓN PLUS" y doble piecero.
Botonera con puerto USB de serie.
Patatas inyectadas negras, de serie.
Patatas opcionales de madera.

Structure in solid pine and fiber board.
Suspension with metal spring.
Foam Seat 35 kg./m³ + 32 kg./m³.
Loose covers.
Only the Power lift options (one and two motors) have the "PLUS RECLINER" system, and the double foot rest.
Keypad with serial USB port. Black injected legs.
Black PVC legs.
Optional wooden legs.

Structure en bois de pin et panneau MDF.
Suspension par ressort métallique.
Assise avec caoutchouc 35 kg./m³ + 32 kg./m³.
Oreillers amovibles.
Dossier amovible de série.
Seules les options de levage électrique (un et deux moteurs) ont un système d'INCLINAISON PLUS et un double repose-pieds.
Clavier avec port USB série.
Jambes injectées noires.
Pieds en bois en option.



Pata inyectada



Negro
Black / Noir

Standard

Genio power lift 1 motor. Tela Channel 17

Medidas	Descripción	zero	SA	SB	SC	SD	TC				
	Genio apertura manual (empuje)	382	428	452	476	500	339	5,9	0,75	40	1
	Genio apertura motorizada (botonera con USB)	529	581	611	641	670	483	5,9	0,75	46,6	1
	Genio power lift 1 motor con doble piecero INCLINACIÓN PLUS (botonera con USB)	620	667	696	725	754	584	5,9	0,75	60,6	1
	Genio power lift 2 motores con doble piecero INCLINACIÓN PLUS (mando con cable)	696	749	778	807	837	656	5,9	0,75	63,2	1
EXTRAS	Cubre-brazo (2 u.) Arm cover (x 2) Couvre bras (x 2)	34	37	40	43	46	30	1	0,02	0,5	1
	Cubre-cabeza Head cover Couvre tête	34	37	40	43	46	30	0,7	0,02	0,5	1
	Kit batería Battery kit Kit batterie	172									
	Calefacción* Heating Le chauffage	84									
	Kit de ruedas** Wheel kit Kit de roue	84									

* La calefacción no es compatible con el kit batería / The heating is not compatible with the battery kit / Le chauffage n'est pas compatible avec le kit batterie.

** Solo posible en versión powerlift 1 y 2 motores / Only possible in 1 and 2 motor powerlift version / Uniquement possible en version powerlift 1 et 2 moteurs.

MECANISMO

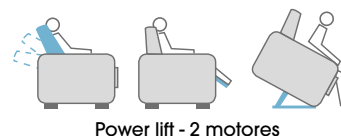
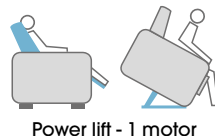

"INCLINACIÓN PLUS"

Con Inclinación extra para un máximo confort y descanso
With extra incline for maximum comfort and rest
Avec inclinaison supplémentaire pour un maximum de confort et de repos

OPCIONAL

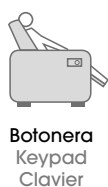

Gravity

Sillón relax



Estructura en madera de pino y tablero MDF.
Suspensión mediante muelles metálicos.
Asiento con goma 28kg./m³ + 28 kg./m³.
Respaldo de goma de 20 kg./m³ S.
Cabezal regulable.
Almohadas desenfundables.
2 medidas de sentada: 57 y 67 cm.
Botonera con puerto USB de serie.

Structure in solid pine and fiber board.
Suspension with metal spring.
Seat with foam 28 kg./m³+ 28 kg./m³
20 kg./m³ S. foam backrest.
Adjustable headrest.
Loose covers.
Optimal seat width: 57 and 67 cm.
Keypad with serial USB port.

Structure en bois de pin et panneau MDF.
Suspension par ressort métallique.
Assise avec caoutchouc 28 kg./m³ + 28kg./m³.
Support en caoutchouc de 20 kg./m³ S.
Tête réglable.
Oreillers amovibles.
2 séances assises: 57 et 67 cm.
Clavier avec port USB série.



Gravity

Cabezal regulable



Gravity ap. motorizada. Tela Amara 395

Medidas	Descripción	zero	SA	SB	SC	SD	TC				
	Gravity fijo	441	475	496	517	538	402	6	0,72	35,9	1
	Gravity apertura manual (tirador exterior)	495	529	550	571	592	456	6	0,72	41,9	1
	Gravity apertura motorizada (botonera con USB)	561	596	616	637	658	522	6	0,72	47,2	1
	Gravity power lift 1 motor (botonera con USB)	669	703	724	745	766	630	6	0,72	49,5	1
	Gravity power lift 2 motores (mando con cable)	699	734	755	776	797	661	6	0,72	57,3	1
	Gravity giratorio y balancín manual (tirador exterior)	511	546	566	587	608	472	6	0,74	48,9	1
	Giratorio y balancín motorizado (botonera con USB)	582	617	638	659	680	544	6	0,74	55,3	1
	Gravity XL fijo (asiento extra ancho de 67)	457	493	515	536	558	417	6,4	0,83	37,3	1
	Gravity XL motorizado (asiento extra ancho de 67) (botonera con USB)	589	625	646	668	690	549	6,4	0,83	48,3	1
EXTRAS	Cubre-cabeza Head cover / Couvre tête	34	37	40	43	46	30	0,9	0,02	0,5	1
	Cubre-brazo (2 u.) Arm cover / Couvre bras (x 2)	34	37	40	43	46	30	0,7	0,02	0,5	1
	Kit batería Battery kit / Kit batterie	172									

MECANISMO

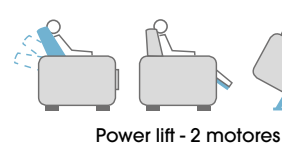
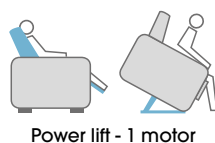

OPCIONAL



EXTRAS



Diverso

Sillón relax



Diverso de 84 cm. (asiento de 57 cm.)



Diverso XL de 94 cm. (asiento de 67 cm.)

Acabado de pata madera

Leg finish / Finition des jambes

Natural Natural Naturel	Cerezo Cherry Cerise	Roble Oak Chêne
Standard		
Wengué Wenge Wengé	Nogal Walnut Noyer	Nogal rústico Rustic walnut Noyer rustique

*Consultar para acabados especiales
Ask for special finishes
Consulter pour les finitions spéciales

Tarifa de SOFÁ DIVERSO





pag. 92



Estructura de pino y tablero MDF.
Suspensión con muelles metálicos.
Asiento con goma de 30 kg./m³.
Respaldo de fibra reciclada.
Almohadas y cubre-brazos desenfundables.
Botonera con puerto USB, de serie.
Patatas de haya maciza, color natural.

Structure in solid pine and fiber board.
Metal spring suspension.
Foam seat 30 kg./m³.
Back cushion filled with recycled fiber.
Removable covers on seat, back and arm.
Keypad with USB port, as standard.
Solid beech legs.

Structure en pin et panneau MDF.
Suspension par ressort métallique.
Siège avec caoutchouc de 30 kg./m³.
Rempli de fibre recyclée.
Oreillers et accoudoirs amovibles.
Clavier avec port USB, standard.
Pieds en hêtre massif.

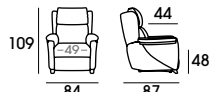
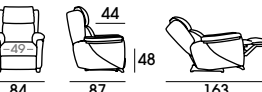
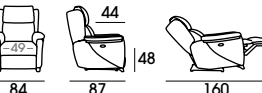
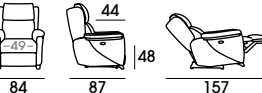
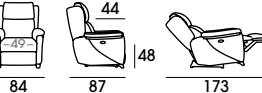
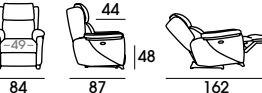
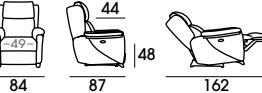
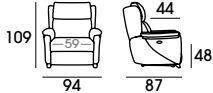
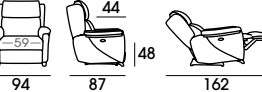
Medidas	Descripción	zero	SA	SB	SC	SD	 Dalmata	TC				
	Diverso FIJO sin mecanismo	384	436	464	491	520	952	363	6,3	0,82	32,5	1
	Diverso apertura manual (tirador exterior)	445	483	505	528	558	1015	403	6,3	0,82	43,9	1
	Diverso apertura motorizada (botonera con USB)	519	571	599	626	655	1092	480	6,3	0,82	48,3	1
	Diverso power lift 1 motor (botonera con USB)	609	661	689	716	745	1215	570	6,3	0,82	57	1
	Diverso power lift 2 motores (mando con cable)	643	711	739	766	795	1258	620	6,3	0,82	61,5	1
	Diverso giratorio y balancín manual (tirador exterior)	462	515	542	570	598	1032	429	6,3	0,85	47,4	1
	Giratorio y balancín motorizado (botonera con USB)	551	603	631	658	687	1113	512	6,3	0,85	51,5	1
	Diverso XL FIJO sin mecanismo (asiento extra ancho de 67)	409	464	494	523	553	1137	367	6,6	0,94	34,6	1
	Diverso XL apertura motorizada (asiento extra ancho de 67) (botonera con USB)	544	599	629	658	688	990	502	6,6	0,94	50,4	1
EXTRAS	Cubre-cabeza Head cover / Couvre tête	34	37	40	43	46	-	30	1	0,02	0,5	1
	Cubre-brazo (2u.) Arm cover / Couvre bras (x 2)	34	37	40	43	46	-	30	1	0,02	0,5	1
	Kit batería Battery kit / Kit batterie	172										

MECANISMO

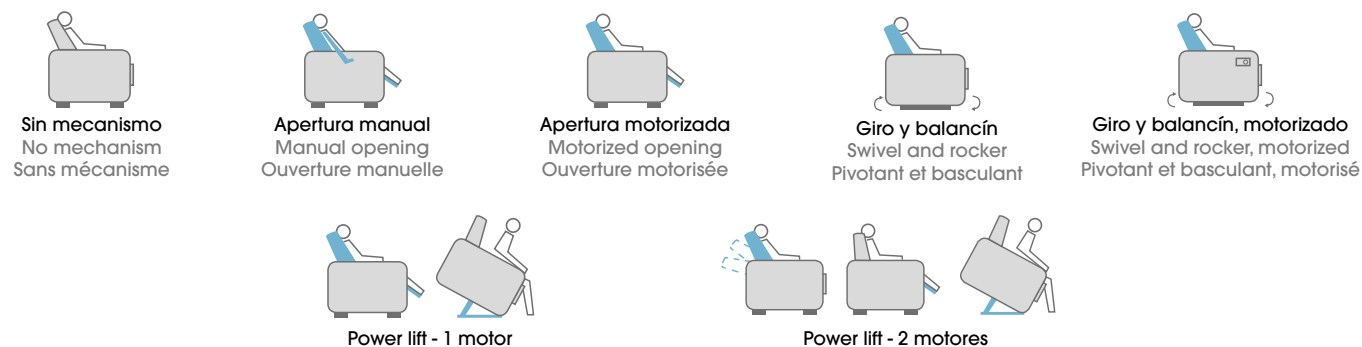

OPCIONAL

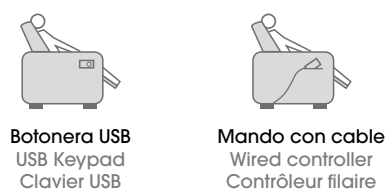

EXTRAS



Básico

Sillón relax

Estructura en madera de pino y tablero MDF.
Suspensión con cincha elástica NEA.
Asiento con goma 30 kg./m³ + 28 kg./m³.
Respaldo de goma de 20 Kg./m³ S.
Botonera con puerto USB de serie.
Patatas inyectadas negras.
Patatas opcionales de madera.

Structure in pine wood and fiber board.
NEA elastic webbing suspension.
30 kg./m³ + 28 kg./m³ rubber seat.
20 Kg./m³ S. foam backrest.
Keypad with serial USB port.
Legs in injected polypropylene, matt black.
Optional wooden legs.

Structure en bois de pin et panneau MDF.
Suspension avec sangle élastique NEA.
Assise avec caoutchouc 35 kg./m³ + 32 kg./m³.
Support en caoutchouc de 20 Kg./m³ S.
Clavier avec port USB série.
Jambes injectées noires.
Pieds en bois en option.



Pata
inyectada



Negro
Black / Noir

Standard

Básico ap. motorizada. Tela Cavalli 2

Medidas	Descripción	zero	SA	SB	SC	SD	TC				
	Básico relax manual (empuje)	348	380	399	418	436	313	5,5	0,7	29,9	1
	Básico apertura motorizada (botonera con USB)	493	524	543	562	581	458	5,5	0,7	34,3	1
	Básico Power lift 1 motor (botonera con USB)	540	573	594	615	635	502	5,5	0,7	42,7	1
	Básico Power lift 2 motores (mando con cable)	578	612	632	653	673	540	5,5	0,7	46,2	1
EXTRAS	Cubre-brazo (2 u.) Arm cover (x 2) Couvre bras (x 2)	34	37	40	43	46	30	0,7	0,02	0,5	1
	Cubre-cabeza Head cover Couvre tête	34	37	40	43	46	30	0,6	0,02	0,5	1
	Kit batería Battery kit Kit batterie	172									
	Kit de ruedas Wheel kit Kit de roue	84									

MECANISMO

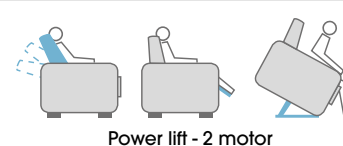
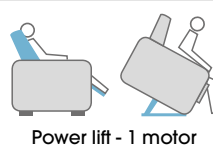

OPCIONAL



EXTRAS



Titán

Sillón relax

Estructura en madera de pino y tablero MDF.
Suspensión con cincha elástica NEA.
Asiento con goma de 32kg./m³ + 35kg./m³.
Respaldo de fibra reciclada.
Cabezal regulable.
Almohadas desenfundables.
Botonera con puerto USB de serie.
Patas de haya maciza, con diferentes acabados.
Cubre brazos de serie.

Structure in pine wood and fiber board.
NEA elastic webbing suspension.
32kg./m³ + 35kg./m³ foam seat.
Recycled fiber backing.
Adjustable headrest.
Loose covers.
Keypad with serial USB port.
Solid beech legs, with different finishes.
Armrest cover as standard.

Structure en bois de pin et panneau MDF.
Suspension sangle élastique NEA.
Assise avec caoutchouc 32kg./m³ + 35kg./m³.
Support en fibres recyclées.
Tête réglable.
Oreillers amovibles.
Clavier avec port USB série.
Pieds en hêtre massif, avec différentes finitions.
Bras de couverture en standard.



Titán apertura manual. Pata de madera natural.

Medidas	Descripción	zero	SA	SB	SC	SD	TC				
	Titán apertura manual (empuje)	345	402	432	461	490	306	5,8	0,65	30,2	1
	Titán apertura motorizada (botonera interior con USB)	498	554	583	613	641	464	5,8	0,65	34,6	1
	Titán power lift 1 motor (botonera interior con USB)	538	595	641	670	700	498	5,8	0,65	43	1
	Titán power lift 2 motor (mando con cable)	586	618	637	657	676	550	5,8	0,65	46,5	1
EXTRAS	Cubre-brazo (2 u.) Arm cover (x 2) Couvre bras (x 2)	34	37	40	43	46	30	0,9	0,02	0,5	1
	Cubre-cabeza Head cover Couvre tête	34	37	40	43	46	30	0,7	0,02	0,5	1
	Kit batería Battery kit Kit batterie	172									
	Calefacción* Heating Le chauffage	84									
	Kit de ruedas** Wheel kit Kit de roue	84									

* La calefacción no es compatible con el kit batería / The heating is not compatible with the battery kit / Le chauffage n'est pas compatible avec le kit batterie.

** Solo posible en versión powerlift 1 y 2 motores / Only possible in 1 and 2 motor powerlift version / Uniquement possible en version powerlift 1 et 2 moteurs.

MECANISMO

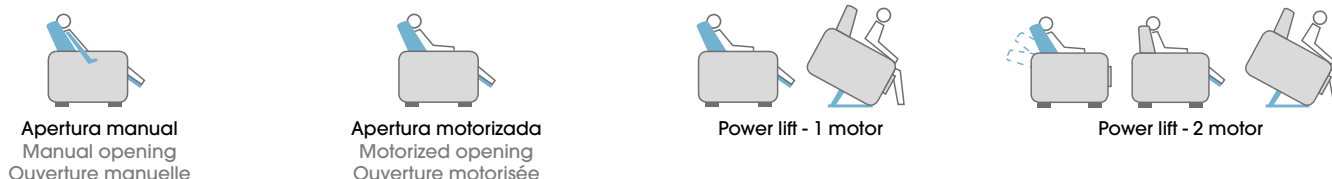

OPCIONAL



Botonera
Keypad
Clavier

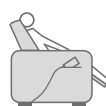

Mando con cable
Wired controller
Contrôleur filaire

EXTRAS



Cubre-brazo
Arm cover
Couvre bras

Standard



Cubre-cabeza
Head cover
Couvre tête



Kit de ruedas
Wheel kit
Kit de roue



Calefacción
Heating
Le chauffage



Kit batería
Battery kit
Kit batterie

Acabado de patas*

Leg finish / Finition des jambes

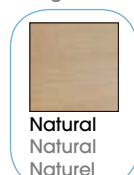

Natural
Natural
Naturel

Standard



Cerezo
Cherry
Cerise



Roble
Oak
Chêne



Wengué
Wenge
Wengé



Nogal
Walnut
Noyer



Nogal rústico
Rustic walnut
Noyer rustique

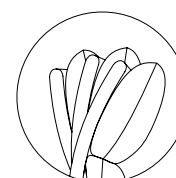

Cabezal regulable.
Adjustable head.
Tête réglable.

*Consultar para acabados especiales / Ask for special finishes / Consulter pour les finitions spéciales

Oliver

Sillón relax

Estructura en madera de pino y tablero MDF.
Suspensión mediante muelle metálico.
Asiento con goma de 32kg./m³ + 35kg./m³.
Respaldo de fibra reciclada.
Almohadas desenfundables.
Funda cubrebrazos de serie.
Botonera con puerto USB de serie.
Patatas de haya maciza, con diferentes acabados.

Structure in pine wood and fiber board.
Metal spring suspension.
23 kg./m³ foam seat.
Back filled with recycled fiber.
Loose covers.
Armrest cover as standard.
Keypad with serial USB port.
Solid beech legs, with different finishes.

Structure en bois de pin et panneau MDF.
Suspension par ressort métallique.
Assise avec caoutchouc 23 kg./m³.
Support en fibres recyclées.
Oreillers amovibles.
Bras de couverture en standard.
Clavier avec port USB série.
Pieds en hêtre massif, avec différentes finitions.



Oliver apertura manual. Pata de madera natural.

Medidas	Descripción	zero	SA	SB	SC	SD	TC				
	Oliver apertura manual (empuje)	337	389	415	441	467	303	5,3	0,78	33,2	1
	Oliver apertura motorizada (botonera con USB)	491	547	573	599	625	457	5,3	0,78	37	1
	Oliver power lift 1 motor (botonera con USB)	551	593	618	667	669	511	5,3	0,78	44,8	1
EXTRAS	Cubre-brazo (2 u.) Arm cover (x 2) Couvre bras (x 2)	34	37	40	43	46	30	0,8	0,02	0,5	1
	Cubre-cabeza Head cover Couvre tête	34	37	40	43	46	30	0,7	0,02	0,5	1
	Kit batería Battery kit Kit batterie	172									
	Calefacción* Heating Le chauffage	84									
	Kit de ruedas** Wheel kit Kit de roue	84									

* La calefacción no es compatible con el kit batería / The heating is not compatible with the battery kit / Le chauffage n'est pas compatible avec le kit batterie.

** Solo posible en versión powerlift 1 y 2 motores / Only possible in 1 and 2 motor powerlift version / Uniquement possible en version powerlift 1 et 2 moteurs.

MECANISMO

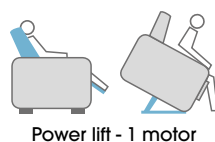

OPCIONAL

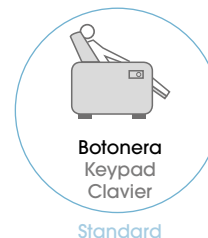

EXTRAS



Acabado de patas* Leg finish / Finition des jambes

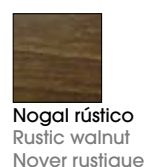
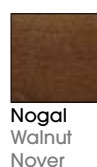
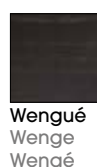
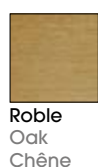
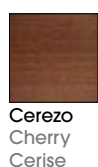

*Consultar para acabados especiales
Ask for special finishes
Consulter pour les finitions spéciales

Enzo

Sillón relax

Estructura en madera de pino y tablero MDF.
Suspensión con cincha elástica NEA.
Asiento con goma 32 kg./m³ + 35 kg./m³.
Respaldo de goma de 30 kg./m³S.
Asiento desenfundable.
Botonera con puerto USB de serie.
Patatas de haya maciza, con diferentes acabados.

Structure in pine wood and fiber board.
NEA elastic webbing suspension.
32kg./m³ + 35kg./m³ foam seat.
30 kg./m³S. foam backrest
Removable seat cover.
Keypad with serial USB port.
Solid beech legs, with different finishes.

Structure en bois de pin et panneau MDF.
Suspension sangle élastique NEA.
Assise avec caoutchouc 35 kg./m³ + 32 kg./m³.
Support en caoutchouc de 30 kg./m³ S.
Siège amovible.
Clavier avec port USB série.
Pieds en hêtre massif, avec différentes finitions.



Enzo apertura manual. Pata de madera natural.

Medidas	Descripción	zero	SA	SB	SC	SD	TC				
	Enzo apertura manual (empuje)	398	429	448	467	486	362	5,3	0,78	35	1
	Enzo apertura motorizada (botonera interior con USB)	544	576	595	614	633	509	5,3	0,78	39,9	1
	Enzo power lift 1 motor (botonera interior con USB)	580	612	631	650	699	545	5,3	0,78	48,6	1
	Enzo power lift 2 motores (mando con cable)	620	651	670	689	709	584	5,3	0,78	51	1
EXTRAS	Cubre-brazo (2 u.) Arm cover (x 2) Couvre bras (x 2)	34	37	40	43	46	30	1,1	0,02	0,5	1
	Cubre-cabeza Head cover Couvre tête	34	37	40	43	46	30	1,1	0,02	0,5	1
	Kit batería Battery kit Kit batterie	172									
	Calefacción* Heating Le chauffage	84									
	Kit de ruedas** Wheel kit Kit de roue	84									

* La calefacción no es compatible con el kit batería / The heating is not compatible with the battery kit / Le chauffage n'est pas compatible avec le kit batterie.

** Solo posible en versión powerlift 1 y 2 motores / Only possible in 1 and 2 motor powerlift version / Uniquement possible en version powerlift 1 et 2 moteurs.

MECANISMO

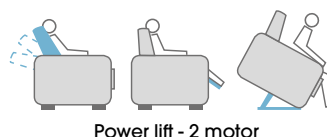
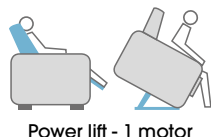

OPCIONAL



EXTRAS



Acabado de patas* Leg finish / Finition des jambes

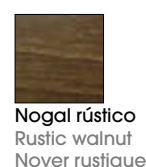
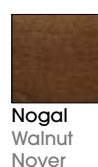
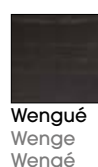
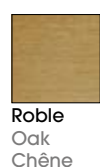
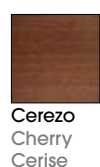

*Consultar para acabados especiales
Ask for special finishes
Consulter pour les finitions spéciales

Benji

Sillón relax

Estructura en madera de pino y tablero MDF.
Suspensión mediante muelle metálico.
Asiento con goma 28 kg./m³.
Respaldo de fibra reciclada.
Almohadas desenfundables.
Botonera con puerto USB de serie.
Patas de haya maciza, con diferentes acabados.

Structure in pine wood and fiber board.
Metal spring suspension.
28kg./m³ foam seat.
Back filled with recycled fiber.
Removable covers.
Keypad with serial USB port.
Solid beech legs, with different finishes.

Armature et bras en métal avec panneau MDF.
Suspension par ressort métallique.
Assise avec caoutchouc de 28kg./m³.
Support en fibre recyclée.
Oreillers amovibles.
Clavier avec port USB série.
Pieds en hêtre massif, avec différentes finitions.



Benji power 1 motor. Pata de madera wengué.

Medidas	Descripción	zero	SA	SB	SC	SD	TC				
	Benji apertura manual (empuje)	364	409	439	469	498	311	6,2	0,81	34	1
	Benji apertura motorizada (botonera con USB)	510	563	593	623	652	472	6,2	0,81	38,2	1
	Benji power lift 1 motor (botonera con USB)	547	605	651	681	711	506	6,2	0,81	47,2	1
	Benji power lift 2 motor (mando con cable)	630	668	691	714	737	587	6,2	0,81	49,9	1
EXTRAS	Cubre-brazo (2 u.) Arm cover (x 2) Couvre bras (x 2)	34	37	40	43	46	30	1,1	0,02	0,5	1
	Cubre-cabeza Head cover Couvre tête	34	37	40	43	46	30	1,1	0,02	0,5	1
	Kit batería Battery kit Kit batterie	172									
	Calefacción* Heating Le chauffage	84									
	Kit de ruedas** Wheel kit Kit de roue	84									

* La calefacción no es compatible con el kit batería / The heating is not compatible with the battery kit / Le chauffage n'est pas compatible avec le kit batterie.

** Solo posible en versión powerlift 1 y 2 motores / Only possible in 1 and 2 motor powerlift version / Uniquement possible en version powerlift 1 et 2 moteurs.

MECANISMO



Apertura manual
Manual opening
Ouverture manuelle



Apertura motorizada
Motorized opening
Ouverture motorisée

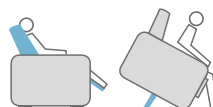

Power lift - 1 motor



Power lift - 2 motor

OPCIONAL

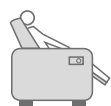

Botonera
Keypad
Clavier

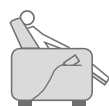

Mando con cable
Wired controller
Contrôleur filaire

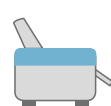

Cubre-brazo
Arm cover
Couvre bras



Cubre-cabeza
Head cover
Couvre tête



Kit de ruedas
Wheel kit
Kit de roue



Calefacción
Heating
Le chauffage

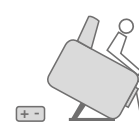

Kit batería
Battery kit
Kit batterie

EXTRAS

Acabado de patas*

Leg finish / Finition des jambes



Natural
Natural
Naturel



Cerezo
Cherry
Cerise



Roble
Oak
Chêne



Wengué
Wenge
Wengé

Standard



Nogal
Walnut
Noyer



Nogal rústico
Rustic walnut
Noyer rustique

*Consultar para acabados especiales
Ask for special finishes
Consulter pour les finitions spéciales

Nativa

Sillón relax



Estructura de pino y tablero MDF.
Suspensión de muelles metálicos.
Asiento con goma de 30 kg/m³.
Respaldo de fibra reciclada.
Almohadas y cubre-brazos desenfundables.
Botonera con puerto USB, de serie.
Opción "Nativa Basic", sin botones ni costuras.

Structure in solid pine and fiber board.
Metal spring suspension.
30kg/m³ foam seat.
Back cushion with recycled fiber.
Removable covers on seat and armrests.
Keypad with USB port, standard.
"Nativa Basic" option, without buttons or stitching.

Structure en pin et panneau MDF.
Suspension à ressort en métal.
Siège en caoutchouc de 30 kg/m³.
Support en fibre recyclée.
Oreiller et couvre-bras amovibles.
Clavier avec port USB, standard.
Option "Nativa Basic", sans boutons ni coutures.



Nativa ap. motorizada.

Nativa sofá

pag. 104



Medidas	Descripción	zero	SA	SB	SC	SD	TC				
	Nativa apertura manual (tirador exterior)	449	489	514	538	562	405	5,8	0,83	43	1
	Nativa apertura motorizada (botonera con USB)	552	592	616	641	665	508	5,8	0,83	45,5	1
	Nativa power lift 1 motor (botonera con USB)	672	712	736	760	784	627	5,8	0,83	47,8	1
	Nativa power lift 2 motores (mando con cable)	706	746	770	794	818	661	5,8	0,83	56,5	1
	Nativa giratorio y balancín manual (tirador exterior)	469	509	533	557	581	424	5,8	0,83	47,7	1
	Nativa giratorio y balancín, motorizado (botonera con USB)	591	631	655	679	703	546	5,8	0,83	54,1	1
EXTRAS	Cubre-brazo (2 u.) Arm cover / Couvre bras (x 2)	34	37	40	43	46	30	0,9	0,02	0,5	1
	Cubre-cabeza Head cover / Couvre tête	34	37	40	43	46	30	0,6	0,02	0,5	1
	Kit batería Battery kit / Kit batterie	172									

MECANISMO



OPCIONAL

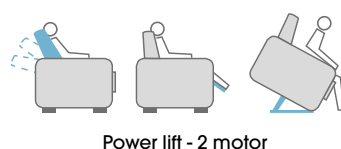
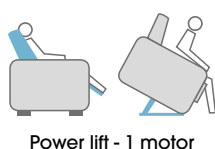

EXTRAS



NATIVA BASIC

Sin botón, sin costuras. Misma tarifa.
No button, no stitching. Same price.
Pas de bouton, pas de coutures. Même taux.

Turbo

Sillón relax

Estructura de madera de pino y tablero MDF.
Suspensión de muelles metálicos.
Asiento con goma de 32kg./m³ + 35kg./m³.
Respaldo de fibra reciclada.
Almohadas desfundables.
Botonera con puerto USB, de serie.
Patas inyectadas negro mate, de serie.
Patas opcionales en madera de haya.

Solid pine and fiber board structure.
Metal spring suspension.
32kg./m³ + 35kg./m³ foam seat.
Back cushion filled with recycled fiber.
Removable loose covers.
Keypad with USB port, standard.
Matt black PP legs.
Optional legs in beech wood.

Structure en bois de pin et panneau MDF.
Suspension à ressort en métal.
Assise avec caoutchouc de 32kg./m³ + 35kg./m³.
Support en fibre recyclée.
Oreillers amovibles.
Clavier avec port USB, standard.
Pieds en polypropylène injecté, noir mat.
Pieds optionnels en bois de hêtre.



Turbo power 2 motores con INCLINACIÓN PLUS. Tela Lido 9.

Pata
inyectada

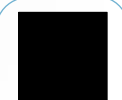

Negro
Black / Noir

Standard

Medidas	Descripción	zero	SA	SB	SC	SD	TC				
	Turbo apertura manual (empuje)	357	391	414	442	470	319	6,1	0,8	33,2	1
	Turbo apertura motorizada (botonera con USB)	506	563	593	623	652	465	6,1	0,8	37,6	1
	Turbo power lift 1 motor (botonera con USB)	540	605	634	663	692	502	6,1	0,8	46,4	1
	Turbo power lift 2 motores (mando con cable)	628	665	687	709	731	588	6,1	0,8	49	1
	Turbo power lift 1 motor INCLINACIÓN PLUS (botonera con USB)	618	661	683	704	726	587	6,1	0,8	51,4	1
	Turbo power lift 2 motores INCLINACIÓN PLUS (mando con cable)	675	720	741	763	784	645	6,1	0,8	53,6	1
EXTRAS	Cubre-brazo (2 u.) Arm cover (x 2) Couvre bras (x 2)	34	37	40	43	46	30	0,6	0,02	0,5	1
	Cubre-cabeza Head cover Couvre tête	34	37	40	43	46	30	0,7	0,02	0,5	1
	Respaldo desmontable Removable backrest Dossier amovible	20									
	Kit batería Battery kit Kit batterie	172									
	Calefacción* Heating Le chauffage	84									
	Kit de ruedas** Wheel kit Kit de roue	84									

* La calefacción no es compatible con el kit batería / The heating is not compatible with the battery kit / Le chauffage n'est pas compatible avec le kit batterie.

** Solo posible en versión powerlift 1 y 2 motores / Only possible in 1 and 2 motor powerlift version / Uniquement possible en version powerlift 1 et 2 moteurs.

MECANISMO

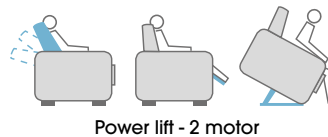
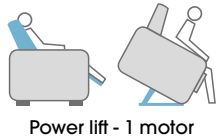

OPCIONAL

EXTRAS

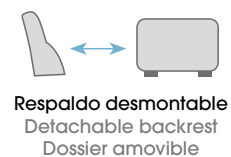

Happy

Sillón relax



Happy con brazo desmontable (opcional)



Happy power 1 motor con INCLINACIÓN PLUS. Botonera con puerto USB interior



Happy power 1 motor con INCLINACIÓN PLUS .Tela channel 16.

Pata inyectada



Negro
Black / Noir

Standard

Estructura de madera de pino y tablero.
Suspensión con cincha elástica NEA.
Asiento con goma de 28kg./m³.
Respaldo de goma de 20kg./m³.
Almohadas desfundables.
Botonera con puerto USB, de serie.
Brazo desmontable opcional.
Patas inyectadas negro mate.
Patas opcionales en madera de haya.

Solid pine and fiber board structure.
NEA elastic webbing suspension.
28 kg./m³ foam seat.
20 kg./m³ foam backrest.
Removable pillows.
Optional detachable arm.
Keypad with USB port, standard.
Matt black PP legs.
Beech legs as option.

Structure en bois de pin et panneau.
Suspension sangle élastique NEA.
Assise avec caoutchouc de 28kg./m³.
Support caoutchouc 20 kg/m³.
Oreillers amovibles.
Bras amovible en option.
Clavier avec port USB, standard.
Pieds injectés noir mat.
Pieds optionnels en bois de hêtre.

Medidas	Descripción	zero	SA	SB	SC	SD	TC				
	Happy fijo	293	327	347	368	388	255	5,3	0,74	30,6	1
	Happy apertura manual (empuje)	326	368	393	419	444	291	5,3	0,74	35,6	1
	Happy apertura motorizada (botonera interior con USB)	482	532	558	584	611	452	5,3	0,74	39,2	1
	Happy power lift 1 motor (botonera interior con USB)	522	584	610	636	662	488	5,3	0,74	47,6	1
	Happy power lift 2 motor (mando con cable)	593	627	647	667	688	555	5,3	0,74	50,2	1
	Happy power lift 1 motor INCLINACIÓN PLUS (botonera interior con USB)	585	635	664	685	705	572	5,3	0,74	52,7	1
	Happy power lift 2 motores INCLINACIÓN PLUS (mando con cable)	641	692	723	743	764	631	5,3	0,74	54,2	1
EXTRAS	Cubre-brazos (2 U.) Arm cover / Couvre bras (X 2)	34	37	40	43	46	30	1	0,02	0,5	1
	Cubre-cabeza Head cover / Couvre tête	34	37	40	43	46	30	0,7	0,02	0,5	1
	Kit batería Battery kit / Kit batterie	172									
	Calefacción* Heating / Le chauffage	84									
	Kit de ruedas** Wheel kit / Kit de roue	84									
	Brazo desmontable*** Detachable arm/Bras détachable	29 (por unidad)									

* La calefacción no es compatible con el kit batería / The heating is not compatible with the battery kit / Le chauffage n'est pas compatible avec le kit batterie.

** Solo posible en versión powerlift 1 y 2 motores / Only possible in 1 and 2 motor powerlift version / Uniquement possible en version powerlift 1 et 2 moteurs.

*** Con 2 brazos desmontables irá con mando / With 2 detachable arms it will go with remote control / Avec 2 bras détachables, il ira avec la télécommande.

MECANISMO

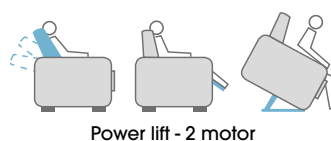
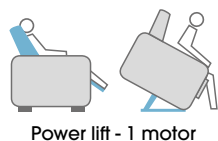

EXTRAS



Dumbo

Sillón relax

Estructura de madera de pino y tablero MDF.
Suspensión con cincha elástica NEA.
Asiento con goma 35 kg./m³ + 32 kg./m³.
Respaldo de fibra siliconada.
Almohadas desfundables.
Patatas de haya con diferentes acabados.

Solid pine and fiber board structure.
NEA elastic webbing suspension.
35 kg./m³+ 32 kg./m³ foam seat.
Back cushion with silicone fiber.
Removable covers.
Beech legs in different finishes.

Structure en bois de pin et panneau MDF.
Suspension sangle élastique NEA.
Assise avec caoutchouc 35 kg./m³ + 32 kg./m³.
Dos en fibre de silicone.
Oreillers amovibles.
Pieds en hêtre avec différentes finitions.



Dumbo ap. manual. Tela Jaipur 20.

Medidas	Descripción	zero	SA	SB	SC	SD	TC				
	Dumbo apertura manual (empuje)	379	409	427	445	465	346	5,7	0,71	34	1
	Dumbo apertura motorizada (botonera interior con USB)	527	557	576	604	631	494	5,7	0,71	38,2	1
	Dumbo power lift 1 motor (botonera interior con USB)	565	599	626	653	680	487	5,7	0,71	50	1
	Dumbo power lift 2 motor (mando con cable)	623	674	701	727	754	584	5,7	0,71	52,3	1
EXTRAS	Cubre-brazo (2 u.) Arm cover (x 2) Couvre bras (x 2)	34	37	40	43	46	30	1	0,02	0,5	1
	Cubre-cabeza Head cover Couvre tête	34	37	40	43	46	30	0,6	0,02	0,5	1
	Kit batería Battery kit Kit batterie	172									
	Calefacción* Heating Le chauffage	84									
	Kit de ruedas** Wheel kit Kit de roue	84									

* La calefacción no es compatible con el kit batería / The heating is not compatible with the battery kit / Le chauffage n'est pas compatible avec le kit batterie.

** Solo posible en versión powerlift 1 y 2 motores / Only possible in 1 and 2 motor powerlift version / Uniquement possible en version powerlift 1 et 2 moteurs.

MECANISMO

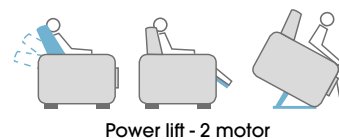
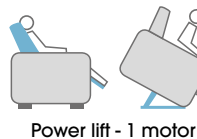

OPCIONAL

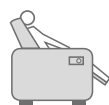

Botonera
Keypad
Clavier

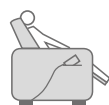

Mando con cable
Wired controller
Contrôleur filaire

EXTRAS



Cubre-brazo
Arm cover
Couvre bras



Cubre-cabeza
Head cover
Couvre tête



Kit de ruedas
Wheel kit
Kit de roue



Calefacción
Heating
Le chauffage



Kit batería
Battery kit
Kit batterie

Acabado de patas* Leg finish / Finition des jambes



Natural
Natural
Naturel



Cerezo
Cherry
Cerise



Roble
Oak
Chêne

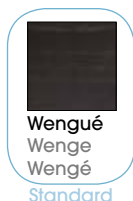

Wengué
Wenge
Wengé
Standard



Nogal
Walnut
Noyer



Nogal rústico
Rustic walnut
Noyer rustique

*Consultar para acabados especiales
Ask for special finishes
Consulter pour les finitions spéciales

Twist

Sillón relax

Estructura de madera de pino y tablero MDF.
Suspensión con cincha elástica NEA.
Asiento con goma 30 kg./m³ + 30 kg./m³ S.
Respaldo de fibra siliconada.
Almohadas desfundables.
Botonera con puerto USB, de serie.
Patas inyectadas en PVC cromo.

Structure in pine wood and fiber board.
NEA elastic webbing suspension.
30 kg./m³+ 30 kg./m³ S foam seat.
Back cushion with silicone fiber.
Keypad with USB port, as standard.
Removable covers.
Cromo PVC legs.

Structure en bois de pin et panneau MDF.
Suspension sangle élastique NEA.
Assise avec caoutchouc 30 kg./m³ + 30 kg./m³ S.
Dos en fibre de silicone.
Oreillers amovibles.
Clavier avec port USB, standard.
Pieds en PVC injecté couleur chrome.



Twist ap. manual.

Pata
inyectada

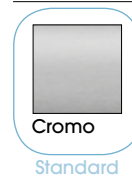

Cromo

Standard



Negro

Black / Noir

Medidas	Descripción	zero	SA	SB	SC	SD	TC				
	Twist apertura manual (empuje)	335	369	395	421	447	292	5,2	0,76	33,4	1
	Twist apertura motorizada (botonera interior con USB)	490	538	568	595	621	464	5,2	0,76	37,4	1
	Twist power lift 1 motor (botonera interior con USB)	523	575	609	635	661	495	5,2	0,76	45,7	1
EXTRAS	Cubre-brazo (2 u.) Arm cover (x 2) Couvre bras (x 2)	34	37	40	43	46	30	1	0,02	0,5	1
	Cubre-cabeza Head cover Couvre tête	34	37	40	43	46	30	0,6	0,02	0,5	1
	Kit batería Battery kit Kit batterie	172									
	Calefacción* Heating Le chauffage	84									
	Kit de ruedas** Wheel kit Kit de roue	84									

* La calefacción no es compatible con el kit batería / The heating is not compatible with the battery kit / Le chauffage n'est pas compatible avec le kit batterie.

** Solo posible en versión powerlift 1 y 2 motores / Only possible in 1 and 2 motor powerlift version / Uniquement possible en version powerlift 1 et 2 moteurs.

MECANISMO



Apertura manual
Manual opening
Ouverture manuelle



Apertura motorizada
Motorized opening
Ouverture motorisée

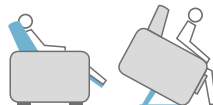

Power lift - 1 motor

OPCIONAL



Botonera
Keypad
Clavier



Mando con cable
Wired controller
Contrôleur filaire

EXTRAS



Cubre-brazo
Arm cover
Couvre bras



Cubre-cabeza
Head cover
Couvre tête



Kit de ruedas
Wheel kit
Kit de roue



Calefacción
Heating
Le chauffage



Kit batería
Battery kit
Kit batterie

Aire

Sillón relax

Estructura de madera y tablero MDF.
Mecanismo relax con pata alta.
Suspensión mediante muelle metálico.
Asiento con goma de 32 kg./m³.
Respaldo en goma de 20 kg./m³ S.
Botonera con puerto USB y botón de recogida automática, de serie.

Metal structure and arms with fiber board.
Relax mechanism with high leg.
Suspension with metal spring.
32 kg./m³ rubber seat.
20 kg./m³ S rubber backrest.
Keypad with USB port and automatic retraction button, as standard.

Structure et bras en métal avec panneau MDF.
Mécanisme relax avec pied haut.
Suspension par ressort métallique.
Assise avec caoutchouc 32 kg./m³.
Dossier en caoutchouc de 20 kg./m³ S.
Clavier avec port USB et bouton de rétraction automatique, en standard.



AIRE ap. manual, con pata alta metálica. Tela Milán 2.

Medidas	Descripción	zero	SA	SB	SC	SD	TC				
	Aire FIJO	318	351	372	392	413	280	5,4	0,76	33,4	1
	Aire apertura manual (empuje)	377	411	431	451	472	339	5,4	0,76	37,4	1
	Aire apertura motorizada (botonera con USB)	472	507	529	550	571	433	5,4	0,76	45,7	1
EXTRAS	Cubre-brazo (2 u.) Arm cover (x 2) Couvre bras (x 2)	34	37	40	43	46	30	1	0,02	0,5	1
	Cubre-cabeza Head cover Couvre tête	34	37	40	43	46	30	0,7	0,02	0,5	1
	Kit batería Battery kit Kit batterie	172									

Acabado de pata madera
Leg finish / Finition des jambes



PM012
Metal
Métal
Standard



Natural
Natural
Naturel



Cerezo
Cherry
Cerise



Roble
Oak
Chêne



Wengué
Wenge
Wengé



Nogal
Walnut
Noyer



Nogal rústico
Rustic walnut
Noyer rustique



Negro
Black
Noir

*Consultar para acabados especiales / Ask for special finishes / Consulter pour les finitions spéciales

MECANISMO

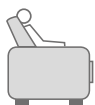

Sin mecanismo
No mechanism
Sans mécanisme



Apertura manual
Manual opening
Ouverture manuelle



Apertura motorizada
Motorized opening
Ouverture motorisée

OPCIONAL



Botonera
Keypad
Clavier

Standard



Mando con cable
Wired controller
Contrôleur filaire

EXTRAS

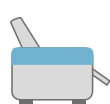

Cubre-brazo
Arm cover
Couvre bras



Cubre-cabeza
Head cover
Couvre tête

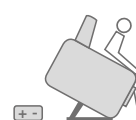

Kit batería
Battery kit
Kit batterie



Menta

Sillón relax

Estructura metálica y brazos con tablero MDF.
Mecanismo alemán de gran calidad.
Suspensión mediante muelle metálico.
Asiento con goma de 32 kg./m³ HR.
Cabezal articulado.
Diferentes opciones de pies y acabados.

Metal structure and arms with fiber board.
High quality German mechanism.
Suspension with metal spring.
32 kg./m³ HR rubber seat.
Articulated headrest .
Different options of feet and finishes.

Structure et bras en métal avec panneau MDF.
Mécanisme allemand de haute qualité.
Suspension par ressort métallique.
Assise avec caoutchouc 32 kg./m³ HR.
Tête articulée.
Différentes options de pieds et de finitions.



Menta manual, con base giratoria BG001



Menta manual, con pata de madera PW021.



Menta manual, con pata metálica PM006

Menta
Sillón relax



Menta manual, con base giratoria BG001.

Menta

Menta

Sillón relax



PM006
Metal
Grafito / Graphite

Color Metal

Metal color / Couleur métal



Grafito
Graphite



BG006
Aspas de aluminio
Matte black aluminum
Aluminium noir mat



BG004
Plato aluminio
Plate aluminum
Aluminium

Color Metal

Metal color / Couleur métal



Negro mate
Matt black
Noir mat



Acero mate
Matte steel
Acier mat



BG001
Metal + madera de fresno
Metal + wood
Métal + bois



BG002
Madera de fresno
Wood
Bois

Acabado de madera*

Wood finish / Finition bois



Natural
Natural
Naturel



Cerezo
Cherry
Cerise



Roble
Oak
Chêne



Wengué
Wenge
Wengé



Nogal
Walnut
Noyer



Nogal rústico
Rustic walnut
Noyer rustique

*Consultar para acabados especiales













Ask for special finishes / Consulter pour les finitions spéciales



PW021
Haya
Beech / Hêtre

Cabecal articulado.
Articulated head rest.
Tête articulée.



Descripción	zero	SA	SB	SC	SD	 Dalmata	TC		 int.	 ext.	 M³	 Kg.	 Uds.
 Menta apertura MANUAL (empuje) + Pata fija PW021 ó PM006	602	661	687	714	742	999	564	4	2	2,5	0,67	36	1
 Menta apertura MOTORIZADA (botonera con puerto USB) + Pata fija PW021 ó PM006	824	883	909	936	964	1221	786	4	2	2,5	0,67	37	1
 Menta apertura MANUAL (empuje) + Base giratoria BG004 ó BG006	704	730	746	762	777	1020	680	4	2	2,5	0,71	42*	1
 Menta apertura MOTORIZADA (botonera con puerto USB) + Base giratoria BG004 ó BG006	926	951	967	983	1000	1240	888	4	2	2,5	0,71	42*	1
 Menta apertura MANUAL (empuje) + Base giratoria BG001 ó BG002	794	820	836	852	867	1110	770	4	2	2,5	0,71	43*	1
 Menta apertura MOTORIZADA (botonera con puerto USB) + Base giratoria BG001 ó BG002	1016	1041	1057	1073	1090	1330	978	4	2	2,5	0,71	44*	1
Kit batería Battery kit / Kit batterie	172												

*Los pesos son aproximados ya que varían dependiendo de la base que se elija.

Menta con pata de madera

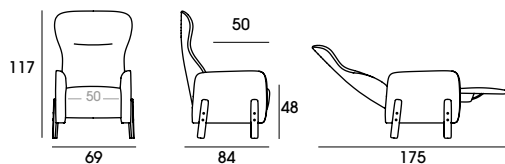

Menta con pata metálica

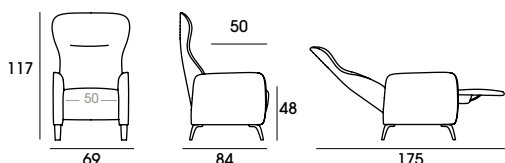

Menta con base giratoria

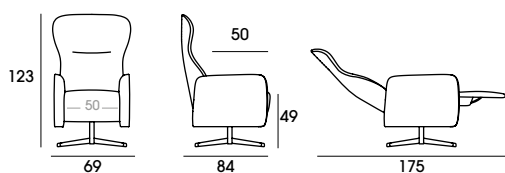

MECANISMO



Apertura manual
Manual opening
Ouverture manuelle

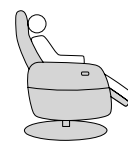

Apertura motorizada
Motorized opening
Ouverture motorisée

EXTRAS

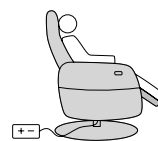

Kit batería.
Battery kit
Kit batterie.

OPCIONAL para mecanismo motorizado

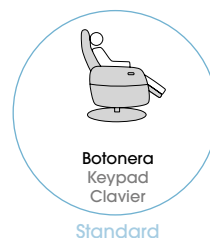

Bora

Sillón relax

Estructura metálica y brazos con tablero MDF.
Mecanismo alemán de gran calidad.
Suspensión mediante muelle metálico.
Asiento con goma 32 kg./m³ HR.
Cabezal articulado.
Diferentes opciones de pies y acabados.

Metal structure and arms with MDF board.
High quality German mechanism.
Suspension by metal spring.
32 kg./m³ HR rubber seat.
Articulated headrest.
Different options of feet and finishes.





Structure et bras en métal avec panneau MDF.
Mécanisme allemand de haute qualité.
Suspension par ressort métallique.
Assise avec caoutchouc 32 kg./m³ HR.
Tête articulée.
Différentes options de pieds et de finitions.



Bora manual, con base giratoria BG002. Piel Dálmata 79.



Bora manual, con base giratoria BG006. Piel Dálmata 79.

Descripción	zero	SA	SB	SC	SD	Dálmata	TC		int.	ext.	M ³	Kg.	Uds.
 Bora apertura MANUAL (palanca interior) + Base giratoria BG004 ó BG006	696	730	746	762	777	997	673	3,5	2,5	1,6	0,68	36*	1
 Bora apertura MOTORIZADA (botonera con puerto USB) + Base giratoria BG004 ó BG006	926	951	967	983	1000	1194	888	3,5	2,5	1,6	0,68	37*	1
 Bora apertura MANUAL (palanca interior) + Base giratoria BG001 ó BG002	786	820	836	852	867	1087	763	3,5	2,5	1,6	0,68	38*	1
 Bora apertura MOTORIZADA (botonera con puerto USB) + Base giratoria BG001 ó BG002	1016	1041	1057	1073	1090	1284	978	3,5	2,5	1,6	0,68	39*	1
Kit batería Battery kit / Kit batterie	172												

*Los pesos son aproximados ya que varían dependiendo de la base

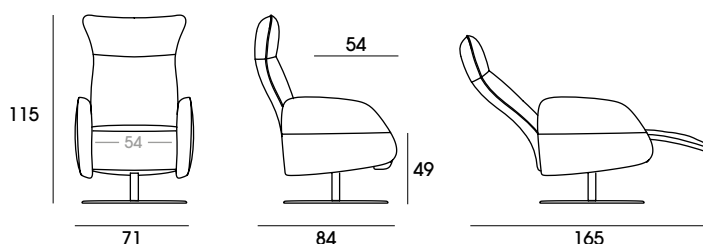

Cabezal articulado.
Articulated head rest.
Tête articulée.

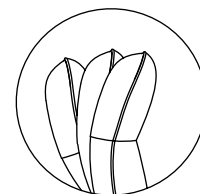

MECANISMO

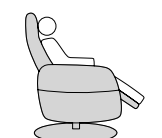

Apertura manual
Manual opening
Ouverture manuelle



Apertura motorizada
Motorized opening
Ouverture motorisée

EXTRAS

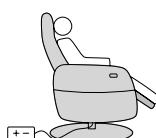

Kit batería.
Battery kit
Kit batterie.

OPCIONAL para mecanismo motorizado

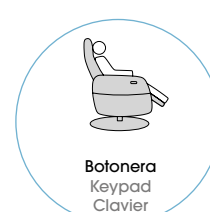

Botonera
Keypad
Clavier

Standard



Mando con cable
Wired controller
Contrôleur filaire



Color Metal

Metal color / Couleur métal



Negro mate
Matt black
Noir mat



Acero mate
Matte steel
Acier mat

Acabado de madera*

Wood finish / Finition bois



BG001
Metal + madera
Metal + wood
Métal + bois



BG002
Madera
Wood
Bois



Natural
Natural
Naturel



Cerezo
Cherry
Cerise



Roble
Oak
Chêne



Wengué
Wenge
Wengé



Nogal
Walnut
Noyer



Nogal rústico
Rustic walnut
Noyer rustique

*Consultar para acabados especiales / Ask for special finishes / Consulter pour les finitions spéciales.

Tempo

Sillón relax

Estructura metálica y brazos con tablero MDF.
Mecanismo alemán de gran calidad.
Suspensión mediante muelle metálico.
Asiento con goma 32 kg./m³ HR.
Cabezal articulado.
Diferentes opciones de pies y acabados.

Metal structure and arms with fiber board.
High quality German mechanism.
Suspension with metal spring.
32 kg./m³ HR rubber seat.
Articulated headrest.
Different options of feet and finishes.





Structure et bras en métal avec panneau MDF.
Mécanisme allemand de haute qualité.
Suspension par ressort métallique.
Assise avec caoutchouc 32 kg./m³ HR.
Tête articulée.
Différentes options de pieds et de finitions.



Tempo manual, con base giratoria BG006. Tela Pacífico Ash.



Tempo manual, con base giratoria BG002. Tela Pacífico Ash.

Descripción	zero	SA	SB	SC	SD	Dálmata	TC		M ³	Kg	Uds
 BG006 Tempo apertura MANUAL (palanca interior) + Base giratoria BG004 ó BG006	696	730	746	762	777	997	673	3,5	0,66	34*	1
 BG004 Tempo apertura MOTORIZADA (botonera con puerto USB) + Base giratoria BG004 ó BG006	926	951	967	983	1000	1194	888	3,5	0,66	35*	1
 BG002 Tempo apertura MANUAL (palanca interior) + Base giratoria BG001 ó BG002	786	820	836	852	867	1087	763	3,5	0,66	36*	1
 BG001 Tempo apertura MOTORIZADA (botonera con puerto USB) + Base giratoria BG001 ó BG002	1016	1041	1057	1073	1090	1284	978	3,5	0,66	37*	1
Kit batería Baffery kit / Kit batterie	172										

*Los pesos son aproximados ya que varían dependiendo de la base

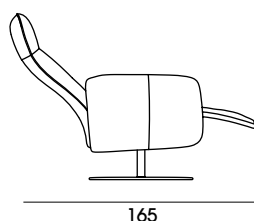
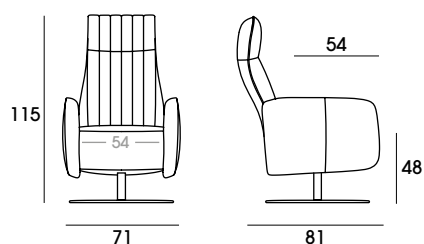

Cabezal articulado.
Articulated head rest.
Tête articulée.

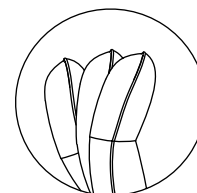

MECANISMO

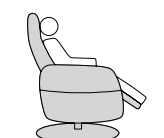

Apertura manual
Manual opening
Ouverture manuelle

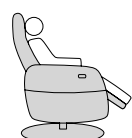

Apertura motorizada
Motorized opening
Ouverture motorisée

EXTRAS

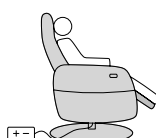

Kit batería.
Baffery kit
Kit batterie.

OPCIONAL para mecanismo motorizado



Botonera
Keypad
Clavier

Standard



Mando con cable
Wired controller
Contrôleur filaire

Color Metal

Metal color / Couleur métal



Negro mate
Matt black
Noir mat



Acero mate
Matte steel
Acier mat

Acabado de madera*

Wood finish / Finition bois



BG001
Metal + madera
Metal + wood
Métal + bois



BG002
Madera
Wood
Bois



Natural
Natural
Naturel



Cerezo
Cherry
Cerise



Roble
Oak
Chêne



Wengué
Wenge
Wengé



Nogal
Walnut
Noyer



Nogal rústico
Rustic walnut
Noyer rustique

*Consultar para acabados especiales / Ask for special finishes / Consulter pour les finitions spéciales.

Panda





Sillón relax

Estructura metálica y brazos con tablero MDF.
Mecanismo alemán de gran calidad.
Suspensión mediante muelle metálico.
Asiento con goma 32 kg./m³ HR.
Respaldo de goma 20 Kg./m³ SS.
Cabezal articulado.
Diferentes opciones de pies y acabados.

Metal structure and arms with fiber board.
High quality German mechanism.
Suspension with metal spring.
32 kg./m³ HR rubber seat.
Rubber backing 20 Kg./m³ SS.
Articulated headrest.
Different options of feet and finishes.

Structure et bras en métal avec panneau MDF.
Mécanisme allemand de haute qualité.
Suspension par ressort métallique.
Assise avec caoutchouc 32 kg./m³ HR.
Dossier en caoutchouc 20 Kg./m³ SS.
Tête articulée.
Différentes options de pieds et de finitions.



Descripción	zero	SA	SB	SC	SD	Dálmata	TC		M ³	Kg	Uds
 BG006 Panda apertura MANUAL (palanca interior) + Base giratoria BG004 ó BG006	708	755	770	786	802	1006	681	3,5	0,66	35*	1
 BG004 Panda apertura MOTORIZADA + Base giratoria BG004 ó BG006	950	976	992	1007	1024	1201	913	3,5	0,66	36*	1
 BG002 Panda apertura MANUAL (palanca interior) + Base giratoria BG001 ó BG002	798	845	860	876	892	1096	771	3,5	0,66	37*	1
 BG001 Panda apertura MOTORIZADA + Base giratoria BG001 ó BG002	1040	1066	1082	1097	1114	1291	1003	3,5	0,66	38*	1
Kit batería Battery kit / Kit batterie	172										

*Los pesos son aproximados ya que varían dependiendo de la base

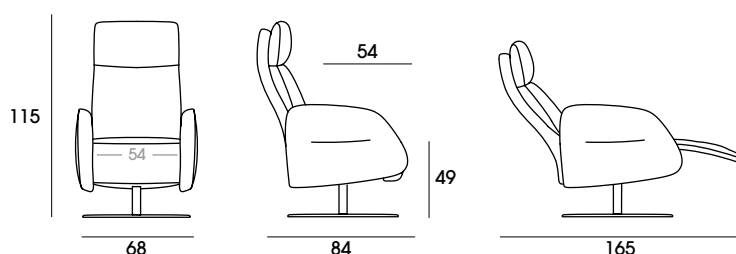

Cabezal articulado.
Articulated head rest.
Tête articulée.

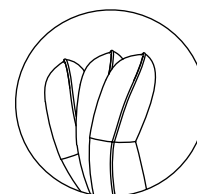

MECANISMO



Apertura manual
Manual opening
Ouverture manuelle

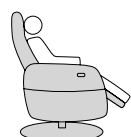

Apertura motorizada
Motorized opening
Ouverture motorisée

EXTRAS

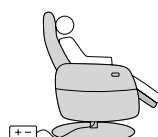

Kit batería.
Battery kit
Kit batterie.

OPCIONAL para mecanismo motorizado



Botonera
Keypad
Clavier

Standard



Mando con cable
Wired controller
Contrôleur filaire



Color Metal

Metal color / Couleur métal



Negro mate
Matt black
Noir mat



Acero mate
Matte steel
Acier mat

Acabado de madera*

Wood finish / Finition bois



BG001
Metal + madera
Metal + wood
Métal + bois



BG002
Madera
Wood
Bois



Natural
Natural
Naturel



Cerezo
Cherry
Cerise



Roble
Oak
Chêne



Wengué
Wenge
Wengé



Nogal
Walnut
Noyer



Nogal rústico
Rustic walnut
Noyer rustique

*Consultar para acabados especiales / Ask for special finishes / Consulter pour les finitions spéciales.



Butacas

Line

Butaca



Butaca Line. Tela Naomi 55

Estructura de madera de pino y tablero.
Asiento de goma de 33 Kg./m³
+ viscolástica.
Respaldos de fibra hueca siliconada
EXTRA CONFORT efecto plumón.
Almohadas desenfundables.
Pata metálica negra de 12 cm.
Permite limpieza con robot aspirador.

Pine wood structure and board.
33Kg./m³ rubber seat + viscoelastic.
EXTRA CONFORT silicone hollow
fiber backrests.
Removable pillows.
12 cm black metal leg.
Allows cleaning with a robot va-
cuum cleaner.

Structure et plateau en bois de pin.
Siège en caoutchouc 33Kg./m³ + viscoélasti-
que.
EXTRA CONFORT Dossiers en fibre creuse silico-
ne effet duvet.
Oreillers amovibles.
Pied en métal noir de 12 cm.
Permet le nettoyage avec un robot aspirateur.



Medidas	Descripción	zero	SA	SB	SC	SD	TC				
	Line	407	432	449	466	483	373	4,8	0,36	42	1
	Line puf	171	178	183	188	192	162	1,1	0,05	6,6	1

Line sofá

pag. 14



PM012
Metal
Métal



12 cm.



Negro
Black
Noir

Oruga Baja

Butaca

Estructura metálica interna, con inyectado de poliuretano 55 Kg./m³ en molde.
Suspensión con muelles de acero.
Poliuretano con normativa ignífuga EN 13501-2
Disponible con diferentes pies y acabados:
Pie con estructura de tubo metálico, con termolacado epoxi.
Pie giratorio con rodamiento de acero y aspas en metal + fresno macizo.

Internal metallic structure.
Mould injection with 55Kg/m³ PU foam.
Metal spring suspension system.
PU foam with FR treatment (EN 13501-2).
Selecection of feet and finishes available:
Metal tube leg epoxy heat laquered.
Swivel base with outer steel ring and spokes in metal with solid ash decoration.

Structure métallique interne, avec polyuréthane injecté 55 Kg./M³ en moule.
Suspension avec ressorts en acier.
Polyuréthane avec réglementation ignifuge EN 13501-2
Disponible avec différents pieds et finitions :
Pied avec structure en tube métallique, thermolaqué époxy.
Pied pivotant avec roulement en acier et lames en métal + frêne massif.



Oruga Baja Pie giratorio metal y madera. Tela Naomi 395

Oruga Baja

Butaca



Medidas	Descripción	zero	SA	SB	SC	SD	TC				
 	Oruga Baja metal	386	398	406	413	421	371	1,9	0,08	6,3	1
 	Oruga Baja base giratoria	450	461	468	474	481	437	1,9	0,08	6,3	1
 	Oruga Baja base giratoria con brazo	534	546	553	561	568	519	1,9	0,08	6,3	1

Acabado de madera*
Wood finish / Finition bois



Color Metal*
Metal color / Couleur métal



*Consultar para acabados especiales / Ask for special finishes / Consulter pour les finitions spéciales.

Oruga Alta

Butaca



Oruga Alta Metal. Tela Naomi 395

Estructura metálica interna, con
inyectado de poliuretano 55Kg./m³
en molde.

Suspensión con muelles de acero.
Poliuretano con normativa ignífuga
EN 13501-2

Disponibile con diferentes pies y
acabados: Pie con estructura de tubo
metálico, con termolacado epoxi, y pie
giratorio con rodamiento de acero y
aspas en metal + fresno macizo.

Internal metallic structure.

Mould injection with 55Kg/m³ PU foam.
Metal spring suspension system.
PU foam with FR treatment (EN 13501-2).

Selecection of feet and finishes available:
Metal tube leg epoxy heat laquered.
Swivel base with outer steel ring
and spokes in metal with solid ash
decoration.

Structure métallique interne, avec
polyuréthane injecté 55Kg./m³ en
moule.

Suspension avec ressorts en acier.
Polyuréthane avec réglementation
ignifuge EN 13501-2

Disponibile avec différents pieds et
finitions : Pied avec structure en tube
métallique, thermolaqué époxy, y pied
pivotant avec roulement en acier et
lames en métal + frêne massif.



Medidas	Descripción	zero	SA	SB	SC	SD	TC				
	Oruga Alta metal	409	421	429	437	445	394	2,1	0,08	6,3	1
	Oruga Alta base giratoria	475	486	493	500	507	461	2,1	0,08	6,3	1
	Oruga Alta base giratoria con brazo	561	573	581	589	597	546	2,1	0,08	6,3	1

Acabado de madera*
Wood finish / Finition bois



Color Metal*
Metal color / Couleur métal



*Consultar para acabados especiales / Ask for special finishes / Consulter pour les finitions spéciales.

Jake

Butaca

Estructura de madera de pino macizo.
Base asiento en tablero MDF microperforado.
Asiento con goma de 30 kg./m³.
Pie en fresno con diferentes acabados.
Pie en hierro con lacado epoxi.

Internal structure of solid pine wood
Seat base in micro-perforated MDF board.
30 kg./m³ foam seat.
Ash foot with different finishes.
Iron foot with epoxy lacquer.

Structure interne en bois de pin massif
Assise en panneau MDF micro-perforé.
Siège avec caoutchouc de 30 kg./m³.
Pied en frêne avec différentes finitions.
Pied en fer laqué époxy.





Medidas		Descripción	zero	SA	SB	SC	SD	TC						
75		Jake butaca (base de varilla de hierro)	312	326	334	342	351	297	2,3	1,4	1,4	0,4	11,3	1
		Jakemate puf (base de varilla de hierro)	158	163	166	169	172	152	1,8	-	-	0,08	6,3	1
75		Jake butaca (base de madera)	346	360	368	376	385	331	2,3	1,4	1,4	0,4	11,3	1
		Jakemate puf (base de madera)	200	205	208	211	214	194	1,8	-	-	0,08	6,3	1

Acabado de madera*
Wood finish / Finition bois



Natural
Natural
Naturel



Cerezo
Cherry
Cerise



Roble
Oak
Chêne



Wengué
Wenge
Wengé



Nogal
Walnut
Noyer



Nogal rústico
Rustic walnut
Noyer rustique

Color Metal*
Metal color / Couleur métal



Negro mate
Matt black
Noir mat

*Consultar para acabados especiales / Ask for special finishes / Consulter pour les finitions spéciales.

Mate

Butaca

Estructura de madera de pino macizo.
Base asiento en tablero MDF microperforado.
Asiento con goma de 30 kg./m³.
Pie en madera o metal con mismo precio.
Pie en fresno con diferentes acabados.
Pie en hierro con lacado epoxi.

Internal structure of solid pine wood.
Seat base in micro-perforated MDF board.
30 kg./m³ foam seat.
Base in wood or metal is the same price.
Ash foot with different finishes.
Iron foot with epoxy lacquer.

Structure interne en bois de pin massif.
Assise en panneau MDF micro-perforé.
Siège avec caoutchouc de 30 kg./m³.
Pied en bois ou métal au même prix.
Pied en frêne avec différentes finitions.
Pied en fer laqué époxy.



Mate con base de hierro.



Mate con base de madera



Medidas		Descripción	zero	SA	SB	SC	SD	TC		int.	ext.			
91		Mate butaca (base de varilla de hierro)	320	335	344	353	362	304	3	1,5	1,5	0,49	15	1
		Jakemate puf (base de varilla de hierro)	158	163	166	169	172	152	1,8	-	-	0,08	6,3	1
91		Mate butaca (base de madera)	354	369	378	387	396	337	3	1,5	1,5	0,49	15,1	1
		Jakemate puf (base de madera)	200	205	208	211	214	194	1,8	-	-	0,08	6,3	1

Acabado de madera*
Wood finish / Finition bois



Natural
Natural
Naturel



Cerezo
Cherry
Cerise



Roble
Oak
Chêne



Wengué
Wenge
Wengé



Nogal
Walnut
Noyer



Nogal rústico
Rustic walnut
Noyer rustique

Color Metal*
Metal color / Couleur métal



Negro mate
Matt black
Noir mat

*Consultar para acabados especiales / Ask for special finishes / Consulter pour les finitions spéciales.

Moli Lisa

Butaca



Moli lisa baja



Moli lisa alta con puf



Moli 2 pl. lisa baja

Estructura de madera de pino macizo.
Suspensión con cincha elástica NEA.
Asiento con goma de 28 kg./m³.
Almohada de asiento desenfundable.
Cojín de reposapiés desenfundable.
Zócalo en madera de haya maciza.

Internal structure in solid pine.
NEA elastic webbing suspension.
28 kg./m³ rubber seat.
Removable seat pillow.
Removable footrest cushion.
Base in solid beech wood.

Structure intérieure en pin massif brossé.
Suspension sangle élastique NEA.
Assise avec caoutchouc de 28 kg./m³.
Oreiller de siège amovible.
Removable footrest cushion.
Base en bois de hêtre massif.

Medidas	Descripción	zero	SA	SB	SC	SD	TC		int.	ext.			
	Moli lisa 1 pl. BAJA	382	400	411	421	432	362	2,7	1,9	1,2	0,56	16,9	1
	Moli lisa 2 pl. BAJA	498	522	536	551	565	472	3,6	2,4	1,5	0,94	28,1	1
	Moli lisa 1 pl. ALTA	393	412	423	434	445	373	2,8	2	1,5	0,66	17,9	1
	Moli lisa 2 pl. ALTA	518	547	565	583	601	485	4,2	2,6	1,8	1,12	30,2	1
	Moli puf	172	179	183	187	192	163	1,2	0,8 base	1 asiento	0,09	7,4	1
	Moli Kids lisa 1pl.	271	281	286	292	298	260	2	1,2	0,9	0,26	4,9	1
	Moli Kids puf	134	139	142	145	148	129	1	0,7 base	0,7 asiento	0,03	2,9	1

Acabado de madera*
Wood finish / Finition bois



Natural
Natural
Naturel



Cerezo
Cherry
Cerise



Roble
Oak
Chêne



Wengué
Wenge
Wengé



Nogal
Walnut
Noyer



Nogal rústico
Rustic walnut
Noyer rustique

*Consultar para acabados especiales / Ask for special finishes / Consulter pour les finitions spéciales

Moli Kids

Misma calidad, con medidas adaptadas a los más pequeños.

Same quality, with measures adapted to kids.

Même qualité, avec des mesures adaptées aux enfants.



Moli Desenfundable

Butaca



Moli desenfundable baja 1 pl.



Moli desenfundable alta 1 pl.



Moli desenfundable alta 2 pl.

Estructura de madera de pino macizo.
Suspensión con cincha elástica NEA.
Asiento con goma de 28 kg./m³.
Respaldo y asiento desenfundables.
Cojín de reposapiés desenfundable.
Zócalo en madera de haya maciza.

Internal structure in solid pine.
NEA elastic webbing suspension.
28 kg./m³ foam seat.
Removable cover on seat and back.
Removable cover on footrest cushion.
Frame in solid beech wood.

Structure intérieure en pin massif brossé.
Suspension sangle élastique NEA.
Assise avec caoutchouc de 28 kg./m³.
Dossier et assise déhoussables.
Coussin repose-pieds amovible.
Base en bois de hêtre massif.

Moli Desenfundable

Butaca

Medidas	Descripción	zero	SA	SB	SC	SD	TC		int.	ext.	M ³	Kg.	Uds.
	Moli Desenfundable 1 pl. BAJA	404	424	437	449	461	381	2,7	1,9	1,2	0,56	16,9	1
	Moli Desenfundable 2 pl. BAJA	561	591	609	628	646	527	3,6	2,4	1,5	0,94	28,1	1
	Moli Desenfundable 1 pl. ALTA	415	436	449	461	474	391	2,8	2	1,5	0,66	17,9	1
	Moli Desenfundable 2 pl. ALTA	574	591	609	628	646	527	4,2	2,6	1,8	1,12	30,2	1
	Moli puf	156	162	166	182	186	159	1	0,8 base	1 asiento	0,09	7,4	1
	Moli Kids Desenfundable 1pl.	296	309	317	348	357	301	2	1,2	0,9	0,26	4,9	1
	Moli Kids puf	134	139	142	145	148	129	1	0,7 base	0,7 asiento	0,03	2,9	1



Respaldo de fácil desfundado, mediante cremallera.

Backrest easy stripped, by zipper.

Dossier facile à retirer, par fermeture éclair.

Acabado de madera*
Wood finish / Finition bois



Natural
Natural
Naturel



Cerezo
Cherry
Cerise



Roble
Oak
Chêne



Wengué
Wenge
Wengé



Nogal
Walnut
Noyer



Nogal rústico
Rustic walnut
Noyer rustique

*Consultar para acabados especiales
Ask for special finishes / Consulter pour les finitions spéciales

Moli Kids

Misma calidad, con medidas adaptadas a los más pequeños.

Same quality, with measures adapted to kids.

Même qualité, avec des mesures adaptées aux enfants.



Moli Capitoné

Butaca



Moli Capitoné alta 1 pl. con puf

Moli capitoné

Estructura de madera de pino macizo.
Suspensión con cincha elástica NEA.
Asiento con goma de 28 kg./m³.
Almohada de asiento desenfundable.
Zócalo en madera de haya maciza.
Tapizado artesanal con técnica de capitoné clásico.

Internal structure in solid pine.
NEA elastic webbing suspension.
28 kg./m³ foam seat.
Removable seat pillow.
Solid beech wood frame
Hand made upholstery with classic "Chesterfield" effect.

Structure intérieure en pin massif brossé.
Suspension sangle élastique NEA.
Assise avec caoutchouc de 28 kg./m³.
Oreiller de siège amovible.
Pieds en bois de hêtre massif.
Fabriqué à la main avec la technique classique du capitonné.

Moli Capitoné

Butaca



Moli Capitoné baja en piel Dálmata.

Medidas	Descripción	zero	SA	SB	SC	SD	Dálmata	TC		M³	Kg.	Uds.
	Moli capitoné 1 pl. BAJA	655	681	697	712	728	956	626	4	0,53	17,6	1
	Moli capitoné 2 pl. BAJA	832	868	891	913	935	1257	791	5,6	0,89	29	1
	Moli capitoné 1 pl. ALTA	671	698	715	731	748	988	640	4,1	0,62	18,6	1
	Moli capitoné 2 pl. ALTA	858	896	919	942	965	1297	816	5,8	1,05	30,9	1
	Moli capitoné puff	220	225	228	231	234	275	215	0,8	0,06	7,6	1

Acabado de madera*
Wood finish / Finition bois

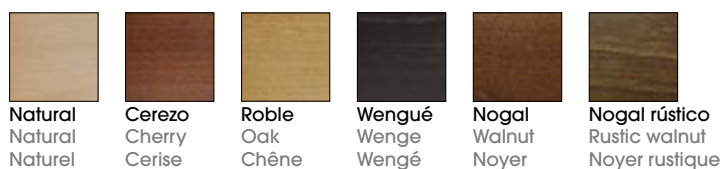

*Consultar para acabados especiales / Ask for special finishes / Consulter pour les finitions spéciales

Mona

Butaca



Mona 1 pl. con puf.



Mona 2 pl. pata de madera color natural.

Estructura de madera de pino macizo.
Suspensión con muelle metálico.
Asiento con goma de 28 kg./m³.
Patatas en madera de haya maciza.

Structure in solid pine.
Suspension with metal spring.
28 kg./m³ foam seat.
Solid beech wood legs.

Structure intérieure en pin massif.
Suspension avec ressort métallique.
Assise avec caoutchouc 28 kg./m³.
Pieds en bois de hêtre massif.

Medidas	Descripción	zero	SA	SB	SC	SD	TC					
	Mona 1 pl.	332	353	366	379	392	309	3,3	0,3	0,64	18	1
	Mona 2 pl.	434	464	483	502	520	399	4,7	0,3	1,04	28,9	1
	Mona 3 pl.	534	572	595	618	642	492	5,8	0,3	1,45	33	1
	Mona puff	125	129	131	134	136	121	0,7	0,3	0,05	6,5	1
	Mona Kids 1 pl.	242	256	264	273	281	226	2,4	0,3	0,26	4,9	1
	Mona Kids puff	113	116	118	119	121	109	0,6	0,2	0,03	2,9	1

Acabado de madera*
Wood finish / Finition bois

Natural Natural Naturel	Cerezo Cherry Cerise	Roble Oak Chêne	Wengué Wenge Wengé	Nogal Walnut Noyer	Nogal rústico Rustic walnut Noyer rustique

*Consultar para acabados especiales
Ask for special finishes / Consulter pour les finitions spéciales

Mona Kids

Misma calidad, con medidas adaptadas a los más pequeños.

Same quality, with measures adapted to kids.

Même qualité, avec des mesures adaptées aux enfants.

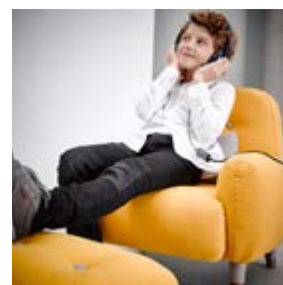

Gemma Madera

Butaca



Gemma madera con puf, color natural. Tela Darven 20.



Gemma madera color nogal. Tela Jaipur 20

Estructura externa en madera de fresno.
Estructura interna en tablero.
Suspensión con muelle metálico.
Asiento con goma de 34 kg./m³.
100% Desenfundable.

External structure in ash wood.
Internal structure in fiber board.
Suspension by metal spring.
34 kg./m³ foam seat.
Removable covers on all cushions.

Structure extérieure en bois de frêne.
Structure interne en pin massif brossé.
Suspension par ressort métallique.
Siège avec caoutchouc de 34 kg./m³.
Oreillers amovibles.



Gemma madera 2 pl. color nogal. Tela Jaipur 20.

Medidas	Descripción	zero	SA	SB	SC	SD	TC				
	Gemma madera 1 pl.	489	510	522	535	548	465	3,3	0,63	19,7	1
	Gemma madera 2 pl.	669	704	725	745	766	631	4,7	0,9	24	1
	Gemma madera puf	150	155	158	162	165	144	0,8	0,06	5,3	1

Acabado de madera*
Wood finish / Finition bois

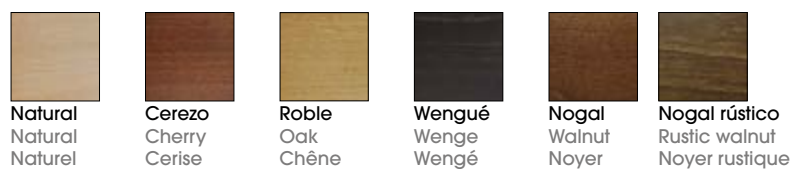

*Consultar para acabados especiales / Ask for special finishes / Consulter pour les finitions spéciales

Gemma Metal

Butaca



Gemma metal 2 pl. Tela Varese 03.



Gemma metal 1 pl. con puf. Tela Varese 03.

Estructura externa en hierro con lacado epoxi ó en acero pulido.
Estructura interna en tablero.
Suspensión con muelles metálicos.
Asiento con goma de 34 kg./m³.
100% Desenfundable.

External structure in iron with epoxy lacquer or in polished steel.
Internal structure in fiber board.
Suspension with metal spring.
34 kg./m³ foam seat.
Removable covers on all cushions.

Structure extérieure en fer laqué époxy ou en acier poli.
Structure interne en panneaux de fibres.
Suspension avec ressort métallique.
Siège avec caoutchouc de 34 kg./m³.
Oreillers amovibles.

Medidas	Descripción	zero	SA	SB	SC	SD	TC				
	Gemma hierro lacado 1 pl.	448	469	482	495	508	425	3,3	0,6	21,8	1
	Gemma hierro lacado 2 pl.	746	780	801	822	843	708	4,7	1,07	38	1
	Gemma puf hierro lacado	190	195	198	201	205	184	0,8	0,06	4,7	1
	Gemma acero pulido 1 pl.	529	550	563	575	588	506	3,3	0,6	21,8	1
	Gemma acero pulido 2 pl.	850	884	905	926	947	812	4,7	1,07	38	1
	Gemma puf acero pulido	256	261	264	267	270	250	0,8	0,06	4,7	1



Gemma en blanco mate.



Gemma en acero pulido.

Color Metal

Metal color / Couleur métal



Standard

Consultar para acabados especiales en colores RAL.
Ask for special finishes in RAL colors. / Consulter pour les finitions spéciales dans les couleurs RAL.

Bimba

Butaca



Butaca Bimba. Tela Varese 20.



Estructura de madera de pino macizo.
Suspensión con cincha elástica NEA.
Asiento con goma de 28 kg./m³.
Relleno de cojín 100% fibra siliconada.
Almohada de asiento desfundable.
Patas en madera de haya maciza.

Internal frame in solid pine.
NEA elastic webbing suspension.
28 kg./m³ foam seat.
100% silicone fiber in cushion padding.
Removable cover on seat cushion.
Solid beech wood legs

Structure intérieure en pin massif brossé.
Suspension sangle élastique NEA.
Assise avec caoutchouc de 28 kg./m³.
Rembourrage de coussin 100% fibre.
Coussin et coussin de siège amovibles.
Pieds en bois de hêtre massif.



Bimba 2 pl. pata de madera color natural. Tela Varese 19.

Medidas	Descripción	zero	SA	SB	SC	SD	TC				
	Bimba 1 pl.	344	364	377	389	402	320	3,2	0,45	21,7	1
	Bimba 2 pl.	465	500	521	542	563	426	4,7	0,74	35,2	1

Acabado de madera*
Wood finish / Finition bois

Natural Natural Naturel	Cerezo Cherry Cerise	Roble Oak Chêne	Wengué Wenge Wengé	Nogal Walnut Noyer	Nogal rústico Rustic walnut Noyer rustique

COJINES
Cushions / Coussins



1 ud.

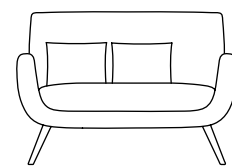

2 ud.

*Consultar para acabados especiales
Ask for special finishes / Consulter pour les finitions spéciales

Malik

Butaca



Malik 1 pl.



Malik 1 pl. Capitoné



Malik 2 pl. Capitoné. Base de madera color natural.

Estructura de madera de pino macizo.
Suspensión con cincha elástica NEA.
Asiento con goma de 30 kg./m³.
Zócalo en madera de haya maciza.
Tapizado artesanal con técnica de capitoné clásico.

Internal structure in solid pine.
NEA elastic webbing suspension.
30 kg./m³ foam seat.
Solid beech wood frame
Hand made upholstery with classic
"Chesterfield" effect

Structure intérieure en pin massif brossé.
Suspension sangle élastique NEA.
Assise avec caoutchouc de 30 kg./m³.
Base en bois de hêtre massif.
Fabriqué à la main avec la technique
classique du capitonné.

Medidas	Descripción	zero	SA	SB	SC	SD	TC				
	Malik 1 pl.	310	327	338	348	358	291	3	0,35	16,9	1
	Malik 2 pl.	423	453	471	489	507	389	4	0,62	29,5	1
	Malik Capitoné 1 pl.	354	373	385	397	409	332	3	0,35	17,1	1
	Malik Capitoné 2 pl.	488	522	543	564	584	450	4	0,62	29,7	1
	Malik Kids Capitoné	254	265	271	278	284	242	2	0,19	5,1	1



Malik 2 pl.

Acabado de madera*
Wood finish / Finition bois

Natural Natural Naturel	Cerezo Cherry Cerise	Roble Oak Chêne	Wengué Wenge Wengé	Nogal Walnut Noyer	Nogal rústico Rustic walnut Noyer rustique

*Consultar para acabados especiales
Ask for special finishes / Consulter pour les finitions spéciales

Malik Kids

Misma calidad, con medidas adaptadas a los más pequeños.

Same quality, with measures adapted to kids.

Même qualité, avec des mesures adaptées aux enfants.



Tapizado capitoné clásico por nuestros tapiceros. Tradición artesana con la máxima calidad.

Classic capitoné upholstery by our upholsterers. Artisan tradition with the highest quality.

Tapiserie d'ameublement classique spéciale par nos tapissiers. Tradition artisanale de la plus haute qualité.

Norik

Butaca



Norik 2 pl. Base de madera color natural.



Norik 1 pl.



Norik 1 pl. Balancín.

Estructura de madera de pino macizo.
Suspensión con cincha elástica NEA.
Asiento con goma de 28 kg./m³.
Asiento desenfundable.
Pie fijo o balancín, en madera de haya.

Internal structure solid pine.
NEA elastic webbing suspension.
28 kg./m³ foam seat.
Removable seat cover.
With legs or rocker, in beech wood.

Structure intérieure en pin massif brossé.
Suspension sangle élastique NEA.
Assise avec caoutchouc de 28 kg./m³.
Siège amovible.
Pied fixe ou bascule, en bois de hêtre.

Medidas	Descripción	zero	SA	SB	SC	SD	TC		detalles			
	Norik 1 pl.	367	391	405	419	434	341	3,7	0,3	0,57	21,3	1
	Norik 2 pl.	515	549	569	590	610	477	5,5	0,3	1,02	25,1	1
	Norik 1 pl. balancín	388	412	426	440	455	362	3,7	0,3	0,57	23,2	1
	Norik Puf	156	162	166	170	174	153	0,9	-	0,07	5,3	1
	Norik Kids balancín	279	297	308	319	330	263	2,4	0,3	0,29	6,5	1

Acabado de madera*
Wood finish / Finition bois

Natural Natural Naturel	Cerezo Cherry Cerise	Roble Oak Chêne	Wengué Wenge Wengé	Nogal Walnut Noyer	Nogal rústico Rustic walnut Noyer rustique

*Consultar para acabados especiales / Ask for special finishes / Consulter pour les finitions spéciales

Norik Kids

Misma calidad, con medidas adaptadas a los más pequeños.

Same quality, with measures adapted to kids.

Même qualité, avec des mesures adaptées aux enfants.



Nemo

Butaca



Nemo 1 pl. madera color natural. Tela Varese 14

Estructura de pino y tablero MDF.
Suspensión con cincha elástica NEA.
Asiento con goma de 30 kg./m³.
Brazos y patas en madera de haya maciza.

Structure in pine wood and fiber board.
NEA elastic webbing suspension.
30 kg./m³ foam seat.
Solid beech wood arms and legs.

Structure en bois de pin et panneau MDF.
Suspension sangle élastique NEA.
Assise avec caoutchouc de 30 kg./m³.
Bras et pieds en bois de hêtre massif.



Nemo 2 pl. Madera color natural. Tela Varese 17.

Medidas	Descripción	zero	SA	SB	SC	SD	TC				
	Nemo 1 pl.	244	255	262	269	275	231	1,7	0,4	12,1	1
	Nemo 2 pl.	370	393	406	420	433	345	4	0,7	20,8	1

Acabado de madera*
Wood finish / Finition bois

Natural Natural Naturel	Cerezo Cherry Cerise	Roble Oak Chêne	Wengué Wenge Wengé	Nogal Walnut Noyer	Nogal rústico Rustic walnut Noyer rustique

*Consultar para acabados especiales
Ask for special finishes / Consulter pour les finitions spéciales

Butaquitas Kids



Moli Kids Desenfundable



Moli Kids Lisa con puf

Medidas	Descripción	zero	SA	SB	SC	SD	TC						
 69 39 63 61	Moli Kids Lisa	271	281	286	292	298	260	2	1,2	0,9	0,26	4,9	1
 69 39 63 61	Moli Kids Desenfundable	296	309	317	348	357	301	2	1,2	0,9	0,26	4,9	1
 27 28 42	Moli Kids puf	134	139	142	145	148	129	1	0,7 base	0,7 asiento	0,03	2,9	1



Mona Kids



Malik Kids



Norik Kids balancín

Acabado de madera*
Wood finish / Finition bois

Natural Natural Naturel	Cerezo Cherry Cerise	Roble Oak Chêne	Wengué Wenge Wengé	Nogal Walnut Noyer	Nogal rústico Rustic walnut Noyer rustique

*Consultar para acabados especiales
Ask for special finishes / Consulter pour les finitions spéciales

Medidas	Descripción	zero	SA	SB	SC	SD	TC					
	Mona Kids	242	256	264	273	281	226	2,4	0,5	0,26	4,9	1
	Mona Kids pouf	113	116	118	119	121	109	0,6	0,3	0,03	2,9	1
	Malik Kids capitoné	254	265	271	278	284	242	2	-	0,19	5,1	1
	Norik Kids balancín	279	297	308	319	330	263	2,4	0,3	0,29	6,5	1



Complementos

Pufs



Puf pata alta







Puf pata alta con arcón



Pufs Capitoné

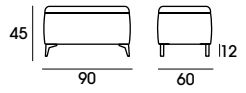
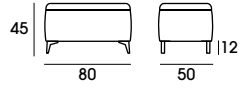
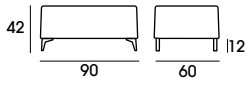
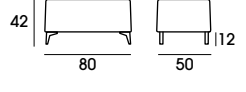
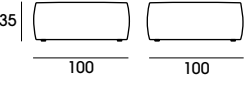
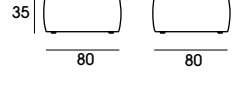
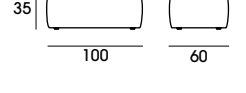
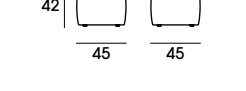
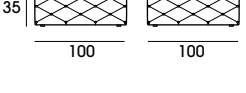
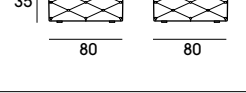
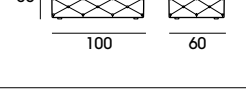
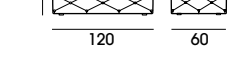

Pufs Lisos

Medidas	Descripción	zero	SA	SB	SC	SD	TC					
	Puf pata alta arcón 90 x 60	310	328	340	351	363	283	545	2,6	0,18	27	1
	Puf pata alta arcón 80 x 50	292	308	317	327	337	269	495	2,2	0,13	25	1
	Puf pata alta 90 x 60	260	273	282	290	298	240	439	1,9	0,16	21	1
	Puf pata alta 80 x 50	242	255	263	271	279	224	412	1,8	0,12	19	1
	Puf pata baja 100 x 100 (circular ó rectangular)	355	388	404	419	454	337	659	3,3	0,35	24	1
	Puf pata baja 80 x 80 (circular ó rectangular)	326	358	374	390	424	308	630	3	0,22	20	1
	Puf pata baja 100 x 60	326	358	374	390	424	308	630	3	0,21	23	1
	Puf pata baja 45 x 45	132	142	148	155	161	118	367	1,6	0,09	8	1
	Puf Capitoné 100 x 100 (circular ó rectangular)	585	601	617	634	657	554	839	4,9	0,35	25	1
	Puf Capitoné 80 x 80 (circular ó rectangular)	552	568	585	601	624	521	807	4,8	0,22	21	1
	Puf Capitoné 100 x 60	552	568	585	601	624	521	807	4,8	0,21	24	1
	Puf Capitoné 120 x 60	585	601	617	634	657	554	839	4,9	0,25	25	1







* Consultáanos para medidas de pufs especiales. Al ser productos hechos uno a uno podemos hacerlo como tú quieras.

* Consult us for measures of special poufs. Being products made one by one we can do it as you want.

* Nous consulter pour les mesures de poufs spéciaux. Étant des produits fabriqués un par un, nous pouvons le faire comme vous le souhaitez.

Colección Pompa



Nº	Descripción	Medidas	Tarifa	M ²	Kg.	Uds.	Acabado de la madera Wood finish / Finition bois
01	Zendo mesa alta	100 x 30 x 65 alto	385	0,19	11,2	1	Colección hecha en madera de fresno proveniente de bosques sostenibles. Collection made of ash wood from sustainable forests.
02	Zendo mesa baja	100 x 30 x 42 alto	370	1,13	8,5	1	
03	Pompa lámpara mod. "A"	9 Ø x 44 alto	109	0,003	0,95	1	Collection en bois de frêne issu de forêts gérées durablement.
04	Pompa lámpara mod "B"	9 Ø x 39 alto	109	0,003	0,95	1	
05	Pompa lámpara mod. "C"	9 Ø x 37 alto	109	0,003	0,95	1	
06	Pompa pomo grande	9 Ø x 5,5 alto	17	0,0002	0,12	1	 Natural Natural Naturel  Roble Oak Chêne  Cerezo Cherry Cerise
07	Pompa pomo pequeño	6,5 Ø x 4 alto	15	0,0001	0,1	1	
08	Pompa espejo grande	70 Ø	274	0,034	8,1	1	
09	Pompa espejo pequeño	46 Ø	169	0,015	3,58	1	 Wengue  Nogal Walnut Noyer  Nogal rústico Rustic walnut Noyer rustique

*Consultar para acabados especiales
Ask for special finishes
Consulter pour les finitions spéciales



Mesita Cruceta



Mesitas Pompa



Mesitas Zendo



Mesita Coffee

Medidas	Descripción	zero	SA	SB	SC	SD	TC				
	POMPA grande 80	350	362	368	375	382	336	1,5	0,3	15,2	1
	POMPA pequeña 60	247	256	261	266	272	235	1,2	0,2	11	1
	Coffe	244						-	0,12	9,4	1
	Cruceta 80 x 80	261						-	0,25	10,6	1
	Zendo Mesa alta	385						-	0,19	11,2	1
	Zendo Mesa baja	370						-	0,13	8,5	1

Acabado de la madera Wood finish / Finition bois



Natural
Natural
Naturel



Roble
Oak
Chêne



Cerezo
Cherry
Cerise



Wengue



Nogal
Walnut
Noyer



Nogal rústico
Rustic walnut
Noyer rustique

Acabado del metal Metal finish / Finition en métal



Negro texturizado
Textured black
Noir texturé

*Consultar para acabados especiales / Ask for special finishes / Consulter pour les finitions spéciales

Cojines



Cojines de 45 x 45 ó 50 x 50
Relleno de fibra reciclada.























Cojines modelo LINE de 50 x 55, con pestaña
francesa y relleno PLUS efecto plumón.



Cojines modelo FLOW, de 50 x 50 con pestaña
ancha. Relleno de fibra reciclada.



Cojines modelo BAOBAB, de 60 x 60 con pestaña
francesa y relleno PLUS efecto plumón

Medidas	Descripción	zero	SA	SB	SC	SD	TC				
 50 50	Cojín 50 x 50	21	25	27	29	35	15	0,7	0,02	0,7	1
 45 45	Cojín 45 x 45	21	25	27	29	35	15	0,8	0,02	0,6	1
 60 60	Baobab cojín 60 x 60 (relleno PLUS efecto plumón)	48	52	55	58	61	42	1	0,05	2	1
 50 55	Line cojín 50 x 55 (relleno PLUS efecto plumón)	48	52	55	58	61	42	0,7	0,04	1,4	1
 50 50	Papúa cojín 50 x 50 (relleno PLUS efecto plumón)	48	52	55	58	61	42	0,7	0,03	1	1
 50 50	Íbero cojín 50 x 50 (relleno PLUS efecto plumón)	48	52	55	58	61	42	0,7	0,03	1	1
 40 60	Tribu cojín 60 x 40	21	25	27	29	35	15	0,8	0,02	0,7	1
 45 45	Mirko cojín 45 x 45	21	25	27	29	35	15	0,7	0,02	0,6	1
 50 50	Flow cojín 50 x 50	21	25	27	29	35	15	0,7	0,03	0,7	1
 35 45	Zendo cojín 45 x 35	21	25	27	29	35	15	0,8	0,02	0,5	1
 40 55	Krema cojín 55 x 40	21	25	27	29	35	15	0,8	0,03	0,6	1
 35 50	Mustang cojín 50 x 35	21	25	27	29	35	15	0,6	0,02	0,6	1
 30 40	Nativa cojín 30 x 40	21	25	27	29	35	15	0,6	0,02	0,5	1
 45 45	Stich cojín 45 x 45	21	25	27	29	35	15	0,7	0,03	0,6	1
 45 55	Wanda cojín 45 x 55	21	25	27	29	35	15	0,8	0,03	0,7	1
 30 50	Botton cojín 30 x 50	21	25	27	29	35	15	0,7	0,02	0,6	1







- . Desenfundable con cremallera.
- . Interior de cojines de TST + fibra HCS reciclada.
- . Asiento acolchado con fibra de poliéster.
- . Funda exterior lavable a máquina según el tejido.

- . Removable zip cover.
- . Interior of cushions lined with ecologic TST fabric and filled with recycled hollow fibre.
- . Base padded with polyester fibres.
- . Removable cover machine washable (check instructions for chosen fabric).

- . Couverture amovible avec fermeture éclair.
- . Intérieur du coussin en fibres TST + HCS recyclées .
- . Assise rembourrée en fibre de polyester.
- . Revêtement extérieur lavable en machine, selon le tissu.

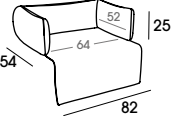
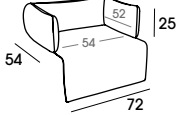
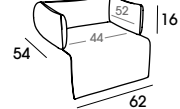

Medidas	Descripción	zero	SA	SB	SC	SD	TC				
	Cuore talla L	87	101	110	119	128	65	2,9	0,16	5	1
	Cuore talla M	70	81	88	95	102	53	2,4	0,12	4	1
	Cuore talla S	66	75	81	87	93	51	2,1	0,8	3	1







- . Desenfundable con cremallera.
- . Interior de cojines de TST + fibra HCS reciclada.
- . Funda exterior lavable a máquina según el tejido.

- . Removable zip cover.
- . Interior of cushions lined with ecologic TST fabric and filled with recycled hollow fibre.
- . Removable cover machine washable (check instructions for chosen fabric)

- . Couverture amovible avec fermeture éclair.
- . Intérieur du coussin en fibres TST + HCS recyclées .
- . Revêtement extérieur lavable en machine, selon le tissu.

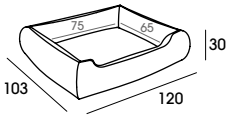
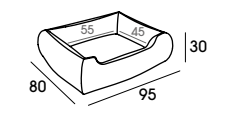
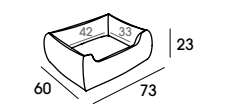

Medidas	Descripción	zero	SA	SB	SC	SD	TC				
	Mía talla L	113	133	146	160	173	79	4,2	0,28	9	1
	Mía talla M	92	108	118	128	138	67	3,3	0,17	6	1
	Mía talla S	70	79	85	92	98	54	2,3	0,10	4	1

Aclaraciones y condiciones de venta

1. Contacta con nosotros.

Tanto si nos conoces desde hace 25 años como si eres un nuevo cliente hemos visto oportuno recordar o informar sobre la organización de nuestra empresa para poder tratar cada tema con el departamento que corresponda ¡y así optimizar tu tiempo!. A continuación detallamos los correos de los diferentes departamentos y que, por supuesto, estaremos encantados de ayudarte:

- **info@reyesordonez.com** (Información en general, te ayudará Raquel)
- **pedidos@reyesordonez.com** (Recepción de pedidos, te ayudará Mercedes)
- **sofas@reyesordonez.com** (Consultas referentes a los sofás, te ayudará Mari)
- **contabilidad@reyesordonez.com** (Departamento de contabilidad, te ayudará Paqui)
- **gestion@reyesordonez.com** (Departamento de facturación, te ayudará Juana María)
- **postventa@reyesordonez.com** (Para cualquier tipo de incidencia, te ayudará Jorge)
- **design@reyesordonez.com** (Departamento de diseño y marketing, te ayudará Majo)

También puedes contactar por teléfono de lunes a viernes en horario de 10 hs. a 14 hs.

2. Claves personales y Extranet

Todos nuestros clientes pueden consultar y hacer un seguimiento a tiempo real de los pedidos que tengan en fabricación. Podréis visualizar el estado del pedido en las diferentes fases de producción, y así poder hacer una previsión aproximada de la fecha de servicio.

¿Cómo puedes acceder a la Extranet?

Es imprescindible solicitar primero tus claves al mail: **info@reyesordonez.com**

Una vez obtenidas, solo tienes que acceder al apartado "extranet" en nuestra web **www.reyesordonez.com**

Te recomendamos que guardes estas claves, ya que también te servirán para hacer consultas futuras y para el "Servicio express"

3. Servicio Express

Este servicio es muy útil para el cliente final que necesita una disponibilidad urgente y que puede adaptarse a los modelos, telas y colores previamente fabricados, o al menos en una fase avanzada de fabricación. Desde la tienda y con vuestras claves personales podréis consultar los productos disponibles, en el apartado "Servicio express".

4. Post venta y garantía

Todos nuestros artículos tienen una garantía de 36 meses, establecida por ley. Siempre y cuando se haga un uso correcto del producto. Las reclamaciones siempre se gestionaran con la tienda y nunca con el cliente final. Para tramitar una incidencia nos tienen que enviar un mail a **postventa@reyesordonez.com** indicando:

- Nombre de la tienda (nombre fiscal)
- Número de factura (Imprescindible para la garantía)
- Explicación detallada del problema a solucionar, fotos y/o vídeos dónde se aprecie la incidencia; esto es de suma importancia, para poder dar solución en el menor tiempo posible.

En caso de deterioro por un uso incorrecto del producto se informará a la tienda del costo de la reparación, necesitando la aceptación del presupuesto para proceder con la reparación.

6. ¿Cómo realizar un pedido?

Todos los pedidos se reciben por mail a la dirección de correo: pedidos@reyesordonez.com

A continuación, te mostramos un ejemplo de pedido.

Puedes descargar esta plantilla en nuestra web, en la sección de "descargas".

Por favor, que no falte esta información:

DATOS DEL PEDIDO:

- Fecha del pedido
- Nombre del cliente
- Dirección
- Contacto
- Referencia del pedido

PEDIDO:

- Modelo y cantidad
- Tipo de mecanismo
- Extras
- Esquema del sofá y mano de chaise longue.
- Tela y color
- Color de patas.

PROPUESTA DE PEDIDO

FECHA: 21/02/2022

CLIENTE: MUEBLES BLANCO E HIJOS

DIRECCIÓN DE ENTREGA: C/DR. CABRERA 27 BAJO. 30510 - YECLA - MURCIA.

TELÉFONO: 615-900900 NOMBRE VENDEDOR/A: MARTÍN

REFERENCIA DEL PEDIDO: Paqui

CANT.	MODELO	DESCRIPCIÓN	PRECIO	TOTAL
1	NATIVA	COMPOSICIÓN CHAISE LONGUE 254 CM.		928,90
		- TELA INDIC 7 - DETALLES INDIC 4		
		- BRAZOS RECTOS		
		- CHAISE FRENTE DERECHA e/INCREMENTO		
		ARCON		44,80
		- PATA MADERA COLOR ROBLE		
				
2	BORA	SILLÓN RELAX BORA	775,60	1551,20
		- PIEL DAKHATA COLOR 30		
		- BASE DE ASPAS NEGRO B6006		
OBSERVACIONES: <u>Por favor llamar cuando esté preparado para entrega en almacén.</u>				TOTAL: <u>2524,90€</u>

En el plazo de 24h. a 48h. recibirás por mail la **confirmación de tu pedido**. Agradecemos que la revises y compruebes que está todo correcto. Daremos por bueno la no respuesta de dicha confirmación de pedido.

5. Metraje y tela cliente

Si necesitas algún metraje de nuestras telas, ten en cuenta que el ancho será de 140cm (+ - 2cm.) El precio que detallamos a continuación es por metro lineal (precio en puntos):

zero	SA	SB	SC	SD
20	26	30	38	42

Cuando nos envíes un metraje (tela cliente) para tapizar uno de nuestros productos, es importante que en el paquete aparezca la siguiente información:

- Nombre (razón social)
- Referencia del pedido
- Indicar la cara "buena" de la tela.

Todos los metrajes de "tela cliente" deberán tener 140 cm. de ancho. El metraje indicado en tarifa se refiere a las telas lisas, sin patrones marcados o dibujos. Si la tela cliente que nos vas a enviar tiene algún patrón marcado, dibujo o es piel natural, te pedimos que nos consultes para asegurarnos de que la tela será suficiente. Los metrajes de "tela cliente" deberán ir siempre en condición de portes pagados.

7. Medidas de nuestros productos y medidas especiales

Todos nuestros productos se miden en centímetros y a mano, y siempre desde la parte que más sobresale del producto, con lo cual, al estar midiendo volúmenes curvos y formas tan orgánicas es posible que puedas encontrar pequeñas variaciones de medidas.

Para productos de medidas especiales te recomendamos consultarnos mediante un croquis o dibujo lo que necesitas para poder estudiar la viabilidad y el coste de dicho proyecto; también, ten en cuenta que los productos con medidas especiales requieren más tiempo de fabricación.

8. Acabados de madera

Tenemos 6 tonos de madera disponibles en nuestra carta habitual, pero ten en cuenta que el tono es orientativo, ya que no es pintura, sino tintura, y por lo tanto depende del color de la madera de base, y de las vetas que esta tenga. Consúltanos para colores especiales.

Acabado de la madera
Wood finish / Finition bois



Natural
Natural
Naturel



Roble
Oak
Chêne

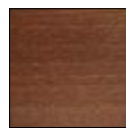

Cerezo
Cherry
Cerise

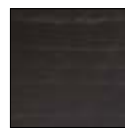

Wengué



Nogal
Walnut
Noyer



Nogal rústico
Rustic walnut
Noyer rustique

9. Aclaraciones generales

- No nos hacemos responsables de posibles errores tipográficos en esta tarifa.

- Por favor, facilítanos una dirección de mail para poder hacerte llegar todas nuestras novedades y cambios que puedas surgir en esta tarifa.

- Queda totalmente prohibida la reproducción o publicación de cualquier producto que aparezca en esta tarifa, así como también la reproducción total o parcial de la misma, sin previa autorización.

Podemos facilitarles nuestras fotos para uso publicitario y de promoción a los clientes que así lo requieran al mail: **design@reyesordonez.com**. Siempre y cuando estén de acuerdo en nombrarnos o etiquetarnos en dichas publicaciones y el producto no vaya acompañado del precio. Con el fin de evitar una "guerra comercial" entre nuestros clientes.

Todos nuestros productos pueden sufrir pequeñas modificaciones o mejoras a medida que avanzamos en la producción de los mismos, con lo cual puede haber pequeñas variaciones entre las fotografías de esta tarifa y el producto. Por ejemplo, en los mandos o botoneras, detalles en las patas etc.

¡Os invitamos a seguirnos en nuestras redes sociales y a etiquetarnos en sus publicaciones para que nosotros también os podamos seguir y compartirlas!



rõ

www.reyesordonez.com

P.I. Las Teresas, c/Dr. Pedro Pons 115
30510 Yecla, Murcia. Apdo. 564
info@reyesordonez.com
+34 968 752 885